

Canon

G2070 series

ΞΕΚΙΝΩΝΤΑΣ

Příručka pro uvedení do provozu

Prvé spustenie

Pierwsze uruchomienie

Beüzemelési útmutató

Başlangıç Kılavuzu

Ghid de inițiere

Ръководство за начално запознаване

Navodila za postavitev in začetek uporabe

Početak

Διαβάστε πρώτα τις **Πληροφορίες για την ασφάλεια και σημαντικές πληροφορίες** (συμπλήρωμα).

Nejprve si přečtete **Informace o bezpečnosti a důležitá sdělení** (dodatek).

Najprv si prečítajte **Informácie o bezpečnosti a dôležité informácie** (dodatok).

Najpierw przeczytaj dodatek **Informacje o bezpieczeństwie i ważne uwagi**.

Először a (mellékelt) **Biztonsági és fontos tudnivalók** című dokumentumot olvassa el!

Önce **Güvenlik ve Önemli Bilgiler** başlıklı eki okuyun.

Citiți mai întâi **Informații cu privire la siguranță și alte informații importante** (anexă).

Прочетете най-напред **Информация за безопасността и важна информация** (приложение).

Najprej preberite **Informacije o varnosti in pomembne informacije** (dodatek).

Najprije pročitajte **Sigurnosne i važne informacije** (dodatak).



Q T 6 4 8 0 2 V 0 1



| |
|--|
| Εγκατάσταση του εκτυπωτή.....σελίδα 1 |
| Instalace tiskárny.....str. 1 |
| Inštalácia tlačiarne.....strana 1 |
| Instalowanie drukarki.....strona 1 |
| A nyomtató üzembe helyezésé.....1. oldal |
| Yazıcıyı Kurma.....sayfa 1 |
| Instalarea imprimantei.....pagina 1 |
| Инсталиране на принтера.....стр. 1 |
| Namestitev tiskalnika.....stran 1 |
| Instaliranje pisača.....stranica 1 |



| |
|--|
| Σύνδεση με υπολογιστή.....σελίδα 6 |
| Připojení k počítači.....str. 6 |
| Pripojenie k počítaču.....strana 6 |
| Łączenie z komputerem.....strona 6 |
| Csatlakoztatás számítógéphez.....6. oldal |
| Bilgisayara Bağlanma.....sayfa 6 |
| Conectarea la un computer.....pagina 6 |
| Свързване с компютър.....стр. 6 |
| Vzpostavljanje povezave z računalnikom.....stran 6 |
| Povezivanje s računalom.....stranica 6 |

Πώς να κρατήσετε τον εκτυπωτή

Jak tiskárnu držet

Ako držat tlačiareň

Trzymanie drukarki

Így kell megfogni a nyomtatót

Yazıcıyı Tutma

Tjinhând imprimanta

Как да държите принтера

Držanje tiskalnika

Držanje pisača

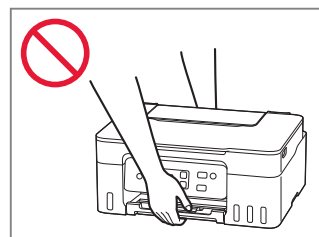
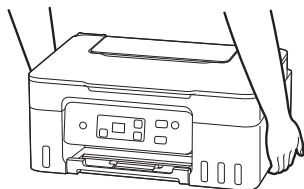

Ρύθμιση του εκτυπωτή

1. Περιεχόμενα συσκευασίας

- Κεφαλές εκτύπωσης

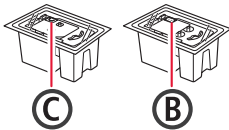

- Φιάλες μελάνης
- Καλώδιο τροφοδοσίας
- CD-ROM εγκατάστασης
- Πληροφορίες για την ασφάλεια και σημαντικές πληροφορίες
- Ξεκινώντας (αυτό το εγχειρίδιο)

2. Ενεργοποίηση του εκτυπωτή

- 1 Συνδέστε το καλώδιο τροφοδοσίας.

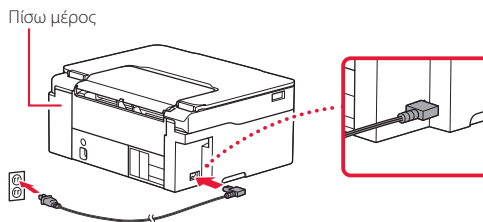

- 2 Πατήστε το κουμπί **ON**.

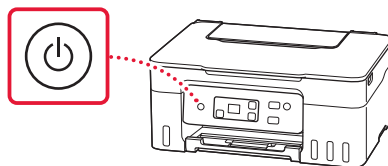

Ρύθμιση του εκτυπωτή

Εύκολη εγκατάσταση με χρήση υπολογιστή



Υπολογιστής

Ρύθμιση με χρήση του παρόντος εγχειριδίου



Ξεκινώντας

3

Εύκολη εγκατάσταση με χρήση υπολογιστή

Στον υπολογιστή σας εμφανίζονται απλές, εύκολες οδηγίες.

- 1 Επισκεφτείτε την παρακάτω διεύθυνση URL για να ξεκινήσετε τη ρύθμιση.

<https://ij.start.canon/G2470>

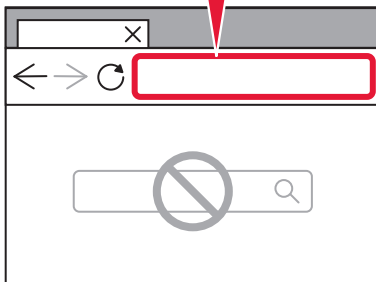

- 2 Ακολουθήστε τις οδηγίες για να ολοκληρώσετε τη ρύθμιση και να εκτυπώσετε.

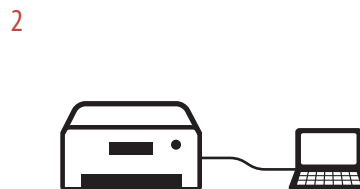
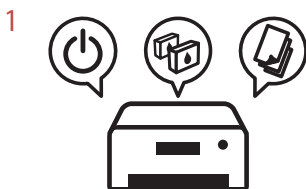

4. Εγκατάσταση των κεφαλών εκτύπωσης

- 1 Ανοίξτε τη μονάδα σάρωσης / κάλυμμα.

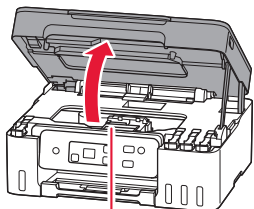

⚠ Προσοχή

Μην αγγίζετε τη θήκη κεφαλής εκτύπωσης μέχρι να σταματήσει να μετακινείται.

- 2 Ανοίξτε το κάλυμμα ασφάλισης κεφαλής εκτύπωσης.

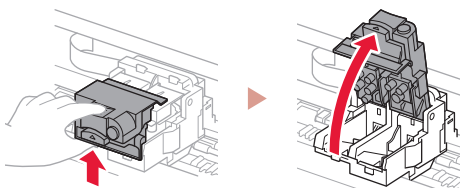

- 3 Βγάλτε κάθε κεφαλή εκτύπωσης από τη συσκευασία και αφαιρέστε την ετικέτα.

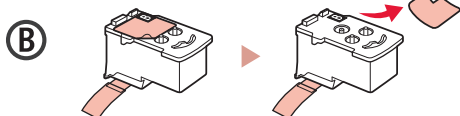
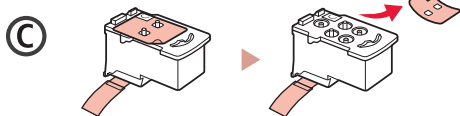

- 4 Αφαιρέστε την πορτοκαλί ταινία.

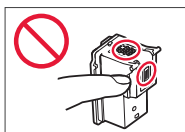
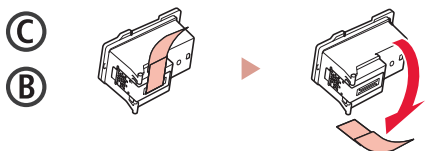

- 5 Τοποθετήστε την C (έγχρωμη) κεφαλή εκτύπωσης στα αριστερά και τη B (μαύρη) κεφαλή εκτύπωσης στα δεξιά.

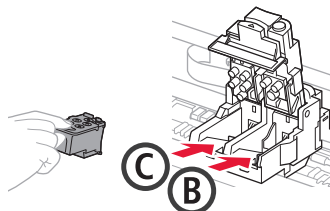

- 6 Κλείστε το κάλυμμα ασφάλισης κεφαλής εκτύπωσης και πιέστε το προς τα κάτω μέχρι να κάνει κλικ.

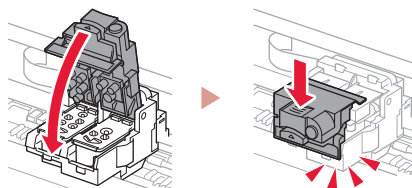

Ρύθμιση του εκτυπωτή

5. Άδειασμα μελάνης

►►► Σημαντικό

Αυτό το προϊόν απαιτεί προσεκτικό χειρισμό της μελάνης. Η μελάνη μπορεί να πιτσιλίζει όταν τα δοχεία μελάνης είναι γεμάτα. Εάν η μελάνη πέσει στα ρούχα ή τα πράγματά σας, μπορεί να μην βγαίνει.

- 1 Ανοίξτε το κάλυμμα δοχείου στα αριστερά του εκτυπωτή.

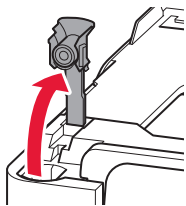

- 2 Κρατήστε τη φιάλη μελάνης όρθια και γυρίστε απαλά το κάλυμμα φιάλης για να το αφαιρέσετε.

Ελέγξτε!

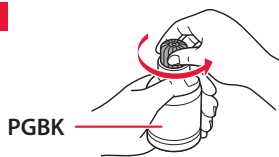

- 3 Ευθυγραμμίστε το ακροφύσιο της φιάλης μελάνης με το σημείο εισροής.

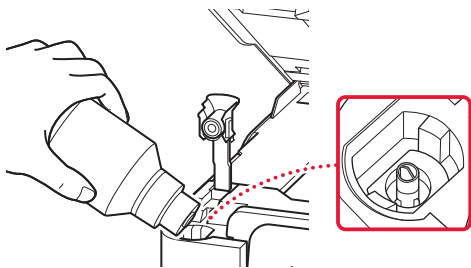

- 4 Κρατήστε αργά τη φιάλη μελάνης ανάποδα και πιέστε προς τα κάτω για να χυθεί η μελάνη.

- Αν δεν χυθεί η μελάνη, αφαιρέστε απαλά τη φιάλη μελάνης και προσπαθήστε ξανά.

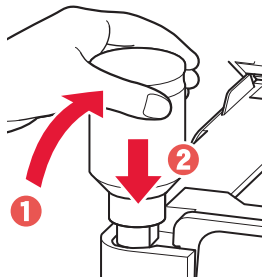

- 5 Αφαιρέστε απαλά τη φιάλη μελάνης από το σημείο εισροής.

- Προσέξτε να μη χυθεί η μελάνη.

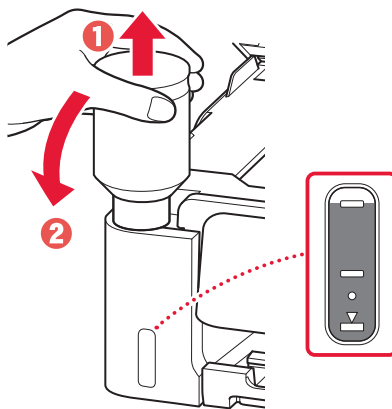

- 6 Τοποθετήστε ξανά το κάλυμμα δοχείου με ασφάλεια.

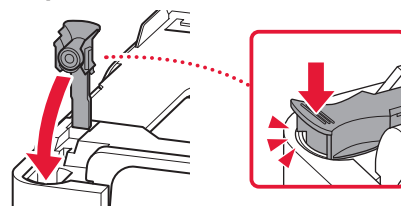

- 7 Επαναλάβετε τα βήματα 1 έως 6 για να αδειάσετε όλη την ποσότητα μελάνης στα αντίστοιχα δοχεία μελάνης στα δεξιά.

Ελέγξτε!

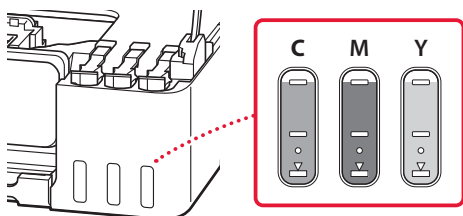

- 8 Κλείστε τη μονάδα σάρωσης / κάλυμμα.
- Εάν ανοίξετε τη μονάδα σάρωσης / το κάλυμμα ελαφρώς και το αφήσετε, θα κλείσει από μόνο του.

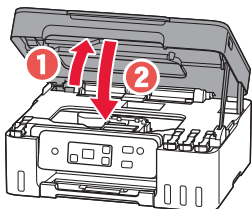

- 9 Όταν εμφανιστεί η ακόλουθη οθόνη, πατήστε το κουμπί **OK**.



- Ξεκινά η προετοιμασία του συστήματος μελάνης. Αυτό παίρνει περίπου 6 λεπτά. Μόλις ολοκληρωθεί, εμφανίζεται η ακόλουθη οθόνη.



Επιλέξτε τη μέθοδο που ταιριάζει καλύτερα στον τρόπο που θα χρησιμοποιείτε τον εκτυπωτή.

- Για χρήση του εκτυπωτή χωρίς σύνδεση σε άλλες συσκευές
 - ➔ Η ρύθμιση έχει ολοκληρωθεί.
- Για χρήση του εκτυπωτή με σύνδεση σε υπολογιστή
 - ➔ Προχωρήστε στην επόμενη σελίδα.

? Αν εμφανιστεί οποιαδήποτε από τις ακόλουθες οθόνες



Αριθμοί ή γράμματα

Ελέγξτε την οθόνη και, στη συνέχεια, ακολουθήστε τις αντίστοιχες οδηγίες παρακάτω.

E04

Οι κεφαλές εκτύπωσης δεν έχουν τοποθετηθεί σωστά.

- ➔ «4. Εγκατάσταση των κεφαλών εκτύπωσης» στη σελίδα 3

E05

Δεν είναι δυνατή η αναγνώριση των κεφαλών εκτύπωσης.

- ➔ «4. Εγκατάσταση των κεφαλών εκτύπωσης» στη σελίδα 3

Για όλες τις λοιπές περιπτώσεις, ανατρέξτε στο **Online εγχειρίδιο**.

6. Σύνδεση με υπολογιστή



Εάν χρησιμοποιείτε πολλούς υπολογιστές, εκτελέστε αυτά τα βήματα σε κάθε υπολογιστή.

- 1 Αποκτήστε απευθείας πρόσβαση στον ιστότοπο Canon. Δεν χρειάζεται να ψάξετε.

<https://ij.start.canon/connect>

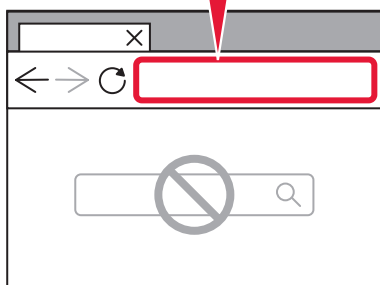

- 2 Καταχωρίστε το όνομα μοντέλου του εκτυπωτή σας και κάντε κλικ στην επιλογή **Μετάβαση**.
- 3 Ακολουθήστε τις οδηγίες στην οθόνη.

Χρήση της CD-ROM εγκατάστασης

1. Κάντε διπλό κλικ στο **EasySetup.exe** στην οθόνη που εμφανίζεται.
2. Εάν εμφανιστεί η οθόνη επιλογής του εκτυπωτή, επιλέξτε **G2470**.
Εάν εμφανιστεί η οθόνη εγκατάστασης, κάντε κλικ στο **Επόμενο (Next)**.
3. Ακολουθήστε τις οδηγίες στην οθόνη.

Εάν δεν εμφανιστεί τίποτα, εκκινήστε το Explorer και, στη συνέχεια, εκτελέστε το **EasySetup.exe** στο CD-ROM.

Τοποθέτηση χαρτιού

- 1 Ανοίξτε την υποστήριξη χαρτιού.

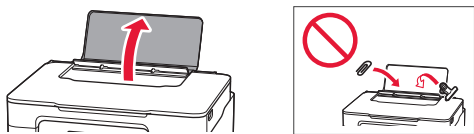

- 2 Σύρετε τον δεξιό οδηγό χαρτιού προς τα δεξιά έως το τέρμα.

- 3 Τοποθετήστε πολλά φύλλα χαρτιού με την πλευρά εκτύπωσης στραμμένη προς τα πάνω και σύρετε τον πλαϊνό οδηγό χαρτιού στην άκρη της στοιβάδας χαρτιών.

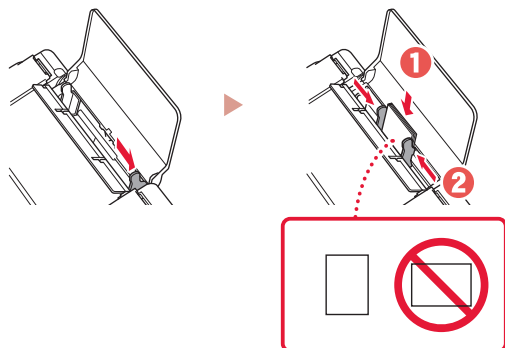

- 4 Πατήστε το κουμπί **Επιλογή χαρτιού (Paper Select)**, επιλέξτε μέγεθος χαρτιού και, στη συνέχεια, πατήστε το κουμπί **OK**.



- 5 Εκτείνετε τη θήκη εξόδου χαρτιού.

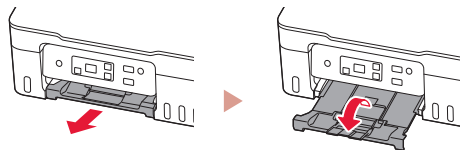

Μεταφορά του εκτυπωτή σας

Κατά τη μετακίνηση του εκτυπωτή, ελέγξτε τα ακόλουθα. Για λεπτομέρειες, ανατρέξτε στο **Online εγχειρίδιο**.

Ελέγξτε εάν τα καλύμματα δοχείου είναι τελείως κλειστά.

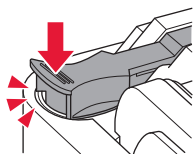

Εάν η θήκη κεφαλής εκτύπωσης βρίσκεται στο κέντρο του εκτυπωτή, ελέγξτε ότι το κάλυμμα είναι κλειστό.

Συσκευάστε τον εκτυπωτή σε μια πλαστική τσάντα σε περίπτωση που διαρρεύσει μελάνη.

- Συσκευάστε τον εκτυπωτή σε ένα ανθεκτικό κιβώτιο ώστε η κάτω πλευρά του να τοποθετηθεί στον πάτο του κιβωτίου, χρησιμοποιώντας επαρκή ποσότητα προστατευτικού υλικού για την ασφαλή μεταφορά του.
- Μη γέρνετε τον εκτυπωτή. Μπορεί να διαρρεύσει μελάνη.
- Δείξτε προσοχή κατά το χειρισμό και φροντίστε η συσκευασία να είναι όρθια και ΟΧΙ ανάποδα ή στο πλάι, καθώς μπορεί να προκληθεί βλάβη στον εκτυπωτή και διαρροή μελάνης.
- Κατά τη μεταφορά του εκτυπωτή από κάποια εταιρεία μεταφορών, φροντίστε να επισημάνετε το κιβώτιο με την ένδειξη «ΑΥΤΗ Η ΠΛΕΥΡΑ ΕΠΑΝΩ» για να παραμείνει η κάτω πλευρά του εκτυπωτή στον πάτο του κιβωτίου. Προσθέστε επίσης τις επισημάνσεις «ΕΥΘΡΑΥΣΤΟ» ή «ΠΡΟΣΕΚΤΙΚΟΣ ΧΕΙΡΙΣΜΟΣ».

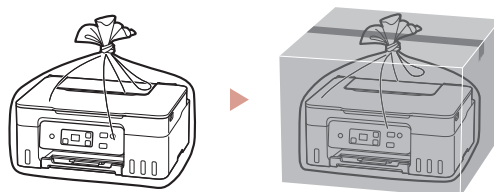

Nastavení tiskárny

1. Obsah balení

- Tiskové hlavy

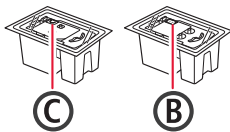

- Láhve na inkoust
- Napájecí kabel
- Instalační disk CD-ROM
- Informace o bezpečnosti a důležitá sdělení
- Příručka pro uvedení do provozu (tato příručka)

2. Zapnutí tiskárny

- 1 Připojte napájecí kabel.

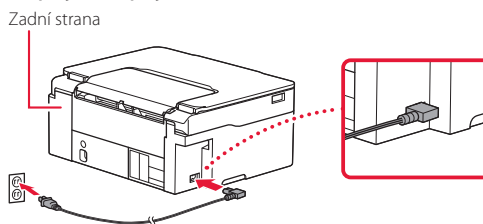

- 2 Stiskněte tlačítko **ZAPNOUT (ON)**.

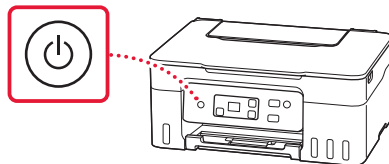

Snadné nastavení z počítače



Počítač

Nastavení pomocí této příručky



Příručka pro uvedení do provozu

3

Snadné nastavení z počítače

Ve vašem počítači se zobrazí jednoduché a přehledné pokyny.

- 1 Nastavení můžete zahájit na následující URL adrese.

<https://ij.start.canon/G2470>

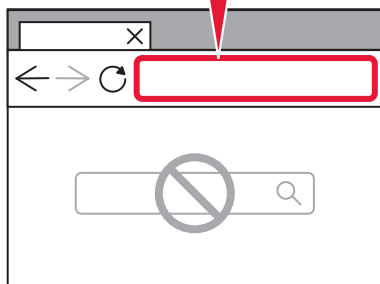

- 2 Podle pokynů dokončete nastavení a přejděte k tisku.

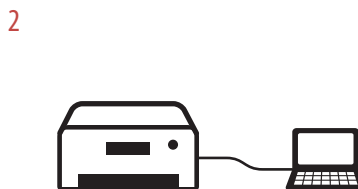
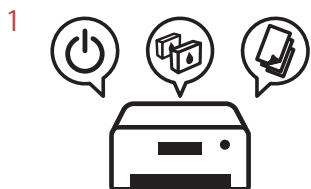

4. Instalace tiskových hlav

- 1 Otevřete skener / kryt.

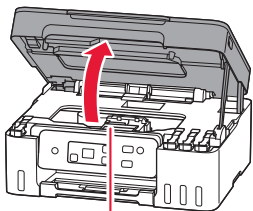

⚠ Upozornění

Nedotýkejte se držáku tiskové hlavy, dokud se nezastaví.

- 2 Otevřete zajišťovací kryt tiskové hlavy.

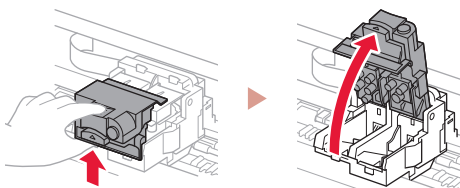

- 3 Vjměte jednotlivé tiskové hlavy z obalu a odstraňte jejich etikety.

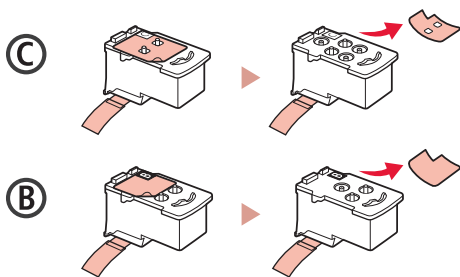

- 4 Odstraňte oranžovou pásku.

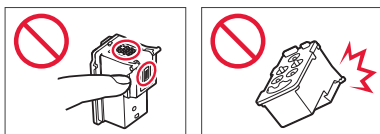
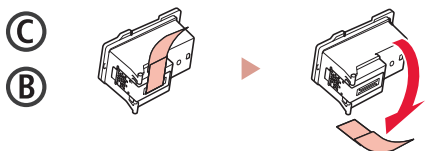

- 5 Vložte tiskovou hlavu C (barevná) vlevo a tiskovou hlavu B (černá) napravo.

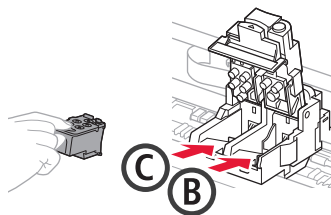

- 6 Zavřete zajišťovací kryt tiskové hlavy a zatlačte jej, až zaklapne na své místo.

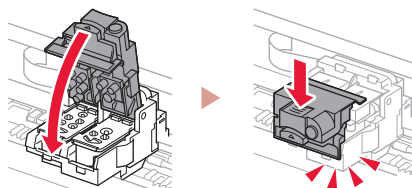

Nastavení tiskárny

5. Nalítí inkoustu

»»» Důležité

Tento produkt vyžaduje opatrné zacházení s inkoustem. Při naplňování nádržek s inkoustem může dojít k potřísnění inkoustem. Pokud se inkoust dostane na váš oděv nebo další předměty, může je nevratně zbarvit.

- 1 Otevřete krytku nádržky v levé části tiskárny.

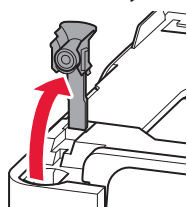

- 2 Láhev na inkoust držte vzpřímeně a lehkým otáčením sejměte krytku láhve.

Nezapomeňte
zkontrolovat!

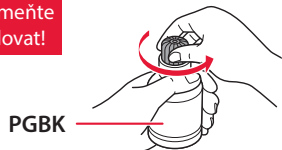

- 3 Zarovnejte trysku láhve na inkoust s přívodem.

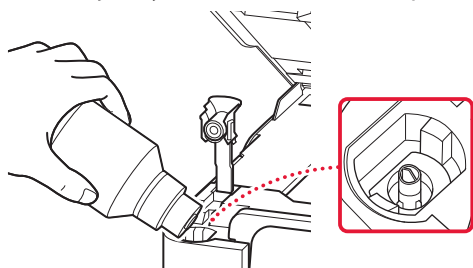

- 4 Pomalu láhev na inkoust narovnejte, aby byla dnem nahoru, zatlačte na ni a nalijte inkoust.

- Pokud inkoust nevytéká, láhev na inkoust vyjměte a akci opakujte.

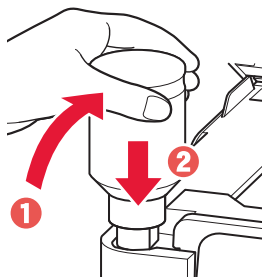

- 5 Láhev na inkoust opatrně vyjměte z přívodu.

- Manipulujte s ní opatrně, aby se inkoust nevylil.

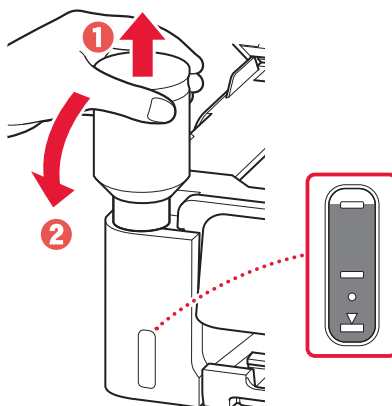

- 6 Bezpečně nasadte krytku nádržky.

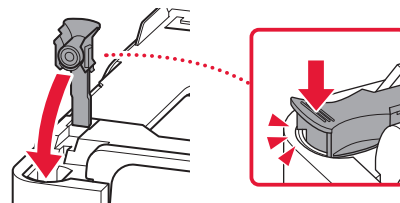

- 7 Zopakováním kroků 1 až 6 nalijte veškerý inkoust do odpovídajících nádržek s inkoustem napravo.

Nezapomeňte zkontrolovat!

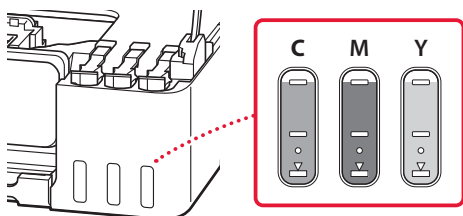

- 8 Zavřete skener / kryt.

- Pokud skener / kryt nadzvednete pouze částečně a pustíte jej, sám se znovu zavře.

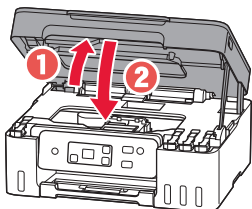

- 9 Pokud se otevře následující obrazovka, stiskněte tlačítko **OK**.



- Spustí se příprava systému inkoustu. Tato akce trvá přibližně 6 minut. Po dokončení se zobrazí následující obrazovka.



Vyberte metodu připojení, která nejlépe vyhovuje zamýšlenému způsobu používání tiskárny.

- **Používání tiskárny bez připojení k dalším zařízením**
 - ➔ Nastavení je tímto dokončeno.
- **Používání tiskárny s připojeným počítačem**
 - ➔ Pokračujte na další stránce.



Pokud se otevře jakákoli z následujících obrazovek



Číslo nebo písmeno

Prohlédněte si informace na obrazovce a postupujte podle příslušných následujících pokynů.

E04

Tiskové hlavy nejsou nainstalovány správně.

- ➔ „4. Instalace tiskových hlav“ na str. 3

E05

Nepodařilo se rozeznat tiskové hlavy.

- ➔ „4. Instalace tiskových hlav“ na str. 3

Ve všech ostatních případech si přečtěte dokument **Příručka online**.

6. Připojení k počítači



Pokud používáte několik počítačů, bude nutné přípravu provést na každém z nich.

- 1 Na web Canon přejděte přímo. Není nutné jej vyhledávat.

<https://ij.start.canon/connect>

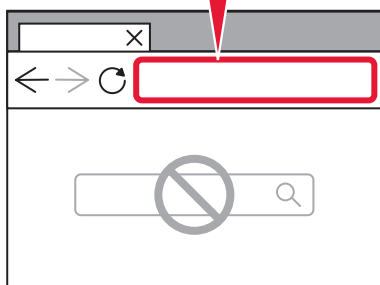

- 2 Zadejte název modelu vaší tiskárny a klepněte na tlačítko **Přejít**.
- 3 Postupujte podle pokynů na obrazovce.

Používání instalačního disku CD-ROM

1. Na nově otevřené obrazovce poklepejte na soubor **EasySetup.exe**.
2. Pokud se otevře obrazovka pro výběr tiskárny, vyberte model **G2470**.
V případě otevření instalační obrazovky klepněte na tlačítko **Další (Next)**.
3. Postupujte podle pokynů na obrazovce.

Pokud se žádné okno neotevře, otevřete Průzkumníka (Explorer) a spusíte soubor **EasySetup.exe** na disku CD-ROM.

Vložení papíru

- 1 Otevřete opěrku papíru.

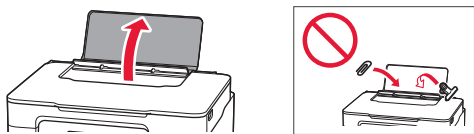

- 2 Posuňte pravé vodítko papíru do pravé krajní polohy.

- 3 Vložte několik listů papíru tiskovou stranou nahoru a přitiskněte boční vodítko papíru ke stohu papíru.

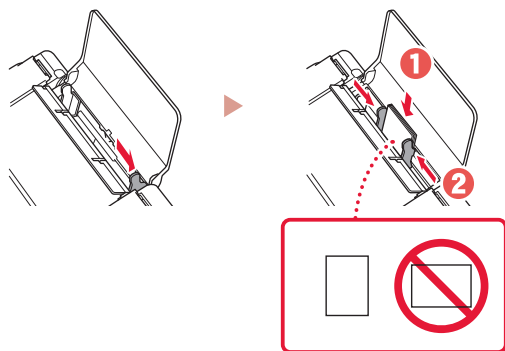

- 4 Stiskněte tlačítko **Výběr papíru (Paper Select)**, vyberte velikost papíru a stiskněte tlačítko **OK**.

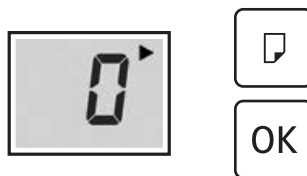

- 5 Vysuňte výstupní zásobník na papír.

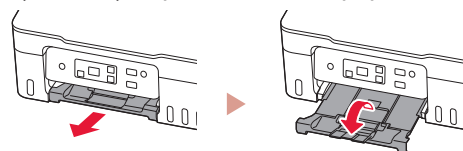

Přeprava tiskárny

Při přepravě tiskárny dodržujte tyto pokyny. Podrobnosti naleznete v dokumentu **Příručka online**.

Ujistěte se, že jsou krytky nádržky zcela uzavřeny.

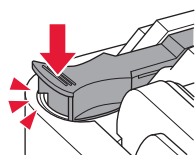

Pokud se držák tiskové hlavy nachází uprostřed tiskárny, ujistěte se, že je kryt zavřený.

Tiskárnu zabalte do plastového pytle pro případ, že by z ní unikl inkoust.

- Zabalte tiskárnu do pevné krabice tak, aby byla umístěno dnem dolů. Použijte dostatečné množství ochranného materiálu, aby přeprava byla bezpečná.
- Tiskárnu nenaklánějte. Může dojít k úniku inkoustu.
- Při manipulaci postupujte obezřetně a dbejte na to, aby balení zůstávalo vždy ve správné poloze, tedy NE hlavou dolů nebo na boku. V opačném případě hrozí poškození tiskárny a únik inkoustu v tiskárně.
- Pokud odesíláte tiskárnu prostřednictvím pošty nebo jiného přepravce, označte balík nápisem „TOUTO STRANOU NAHORU“. Zajistíte tak přepravu tiskárny v poloze dnem dolů. Dodejte také označení „KŘEHKÉ“ nebo „OPATRNĚ“.

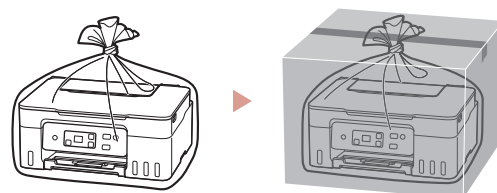

Nastavenie tlačiarne

1. Obsah balenia

- Tlačové hlavy

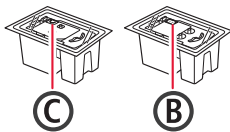

- Flaše s atramentom
- Napájací kábel
- Inštalačný disk
- Informácie o bezpečnosti a dôležité informácie
- Prvé spustenie (táto príručka)

2. Zapnutie tlačiarne

- 1 Pripojte napájací kábel.

Zadná strana

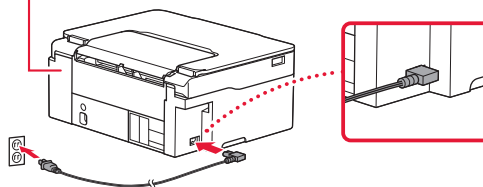

- 2 Stlačte tlačidlo **ZAP. (ON)**.

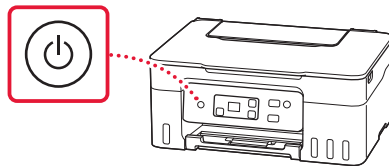

Jednoduché nastavenie pomocou počítača



Počítač

Nastavenie pomocou tejto príručky



Prvé spustenie

3

Jednoduché nastavenie pomocou počítača

Jednoduché a zrozumiteľné pokyny sa zobrazia na vašom počítači.

- 1 Ak chcete spustiť nastavenie, navštívte adresu URL nižšie.

<https://ij.start.canon/G2470>

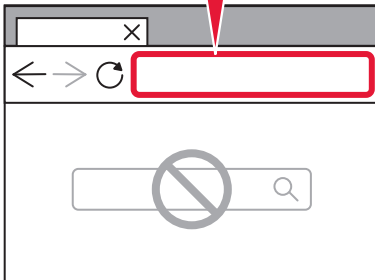

- 2 Podľa pokynov dokončíte nastavenie a tlačte.

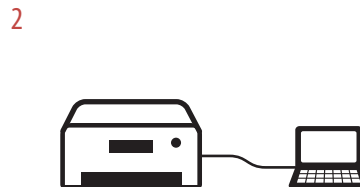
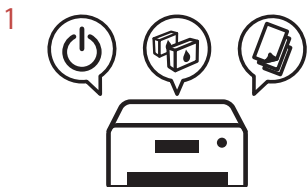

4. Vkladanie tlačových hláv

- 1 Otvorte skenovaciu jednotku/kryt.

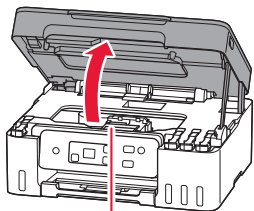

⚠ Upozornenie

Nedotýkajte sa držiaka tlačovej hlavy, kým sa nezastaví.

- 2 Otvorte zaistovací kryt tlačovej hlavy.

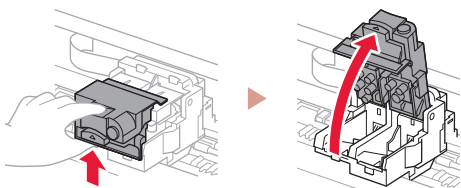

- 3 Z balenia vyberte jednotlivé tlačové hlavy a odstráňte ich štítky.

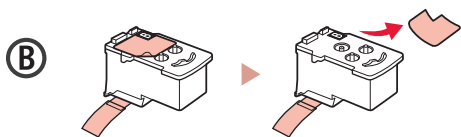
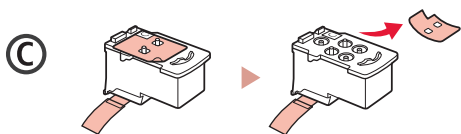

- 4 Odstráňte oranžovú pásku.

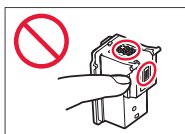
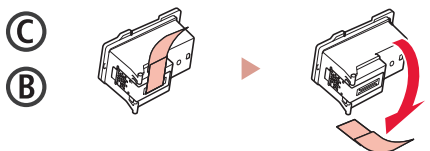

- 5 Zasuňte C (farebnú) tlačovú hlavu na ľavej strane a B (čiernu) tlačovú hlavu na pravej strane.

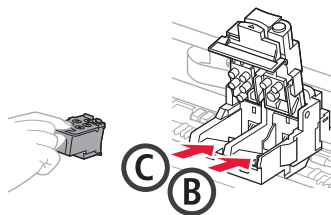

- 6 Zatvorte zaistovací kryt tlačovej hlavy a zatlačte ho nadol, kým nezačujete cvaknutie.

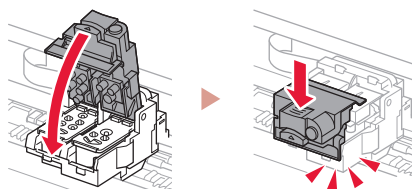

Nastavenie tlačiarne

5. Naliatie atramentu

»»» Dôležité

Tento produkt si vyžaduje opatrnú manipuláciu s atramentom. Z naplnených kaziet s atramentom sa môže vyliat atrament. Ak sa atrament dostane na váš odev alebo iné veci, nemusí byť možné ho odstrániť.

- 1 Otvorte kryt kazety na ľavej strane tlačiarne.

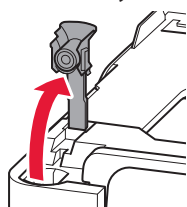

- 2 Podržte fľašu s atramentom vo zvislej polohe a jemným otočením odstráňte kryt fľaše.

Kontrola!

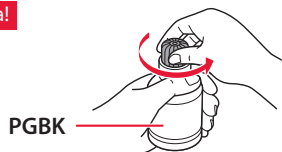

- 3 Zarovnajte dýzu fľaše s atramentom so vstupom.

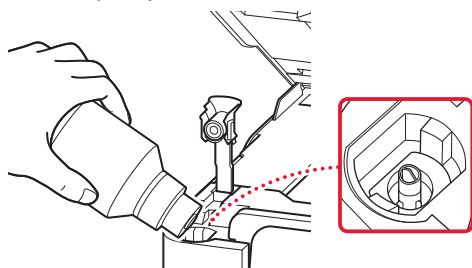

- 4 Pomaly otočte fľašu s atramentom naopak a stlačením nadol nalejte atrament.

- Ak sa atrament neleje, jemne odstráňte fľašu s atramentom a skúste to znova.

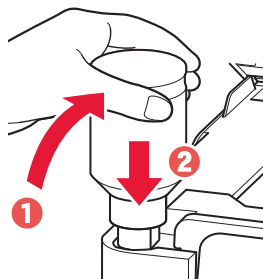

- 5 Jemne odstráňte fľašu s atramentom zo vstupom.

- Dávajte pozor, aby sa atrament nevyliat.

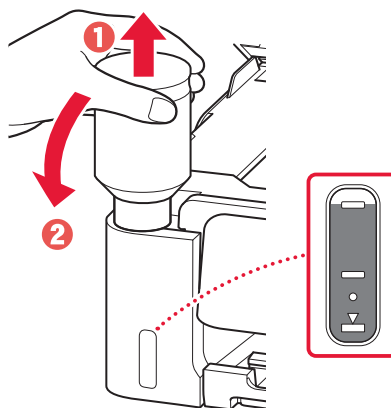

- 6 Bezpečne nasadte kryt kazety.

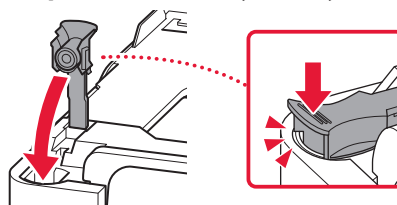

- 7 Zopakujte kroky 1 až 6 na vylatie všetkého atramentu do príslušných kaziet s atramentom vpravo.

Kontrola!

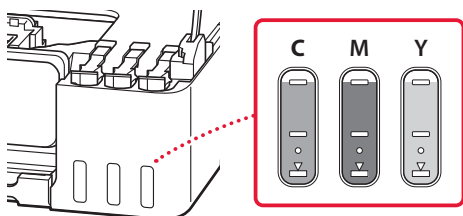

- 8 Zatvorte skenovaciu jednotku/kryt.

- Ak zľahka nadvihnete skenovaciu jednotku/kryt a uvoľníte ho, zatvorí sa sám.

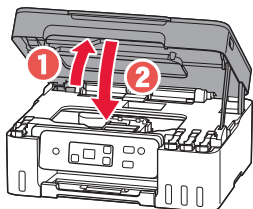

- 9 Keď sa otvorí nasledujúca obrazovka, stlačte tlačidlo **OK**.



- Spustí sa príprava atramentového systému. Potrvá to približne 6 minút. Po dokončení sa zobrazí nasledujúca obrazovka.



Vyberte spôsob pripojenia, ktorý najlepšie zodpovedá vašmu spôsobu používania tlačiarne.

- Používanie tlačiarne bez pripojenia akýchkoľvek iných zariadení
 - ➔ Nastavenie je hotové.
- Používanie tlačiarne pripojením k počítaču
 - ➔ Pokračujte na ďalšiu stranu.



Ak sa otvorí ktorákoľvek z nasledujúcich obrazoviek



Čísla alebo písmená

Skontrolujte obrazovku a postupujte podľa príslušných pokynov uvedených nižšie.

E04

Tlačové hlavy nie sú vložené správne.

- ➔ „4. Vkladanie tlačových hláv“ na strane 3

E05

Tlačové hlavy sa nedajú rozpoznať.

- ➔ „4. Vkladanie tlačových hláv“ na strane 3

Informácie o všetkých ostatných prípadoch nájdete v dokumente **Príručka online**.

6. Pripojenie k počítaču



Ak používate viacero počítačov, zopakujte tieto kroky na každom z nich.

- 1 Prístup priamo k webovej stránke Canon. Netreba hľadať.

<https://ij.start.canon/connect>

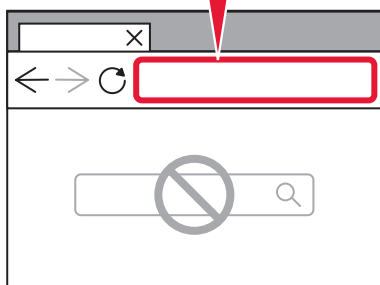

- 2 Zadať názov modelu tlačiarne a kliknite na položku **Prejsť**.
- 3 Postupujte podľa pokynov na obrazovke.

Použitie inštalačného disku

1. Dvakrát kliknite na **EasySetup.exe** na obrazovke, ktorá sa zobrazí.
2. Ak sa zobrazí obrazovka výberu tlačiarne, vyberte položku **G2470**.
Ak sa zobrazí inštalačná obrazovka, kliknite na možnosť **Ďalej (Next)**.
3. Postupujte podľa pokynov na obrazovke.

Ak sa nič nezobrazí, spustíte Prieskumník (Explorer), a potom spustíte **EasySetup.exe** na disku CD-ROM.

Vloženie papiera

- 1 Otvorte podperu papiera.

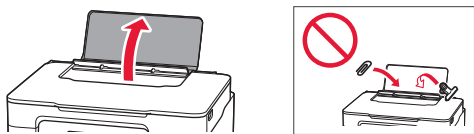

- 2 Posuňte pravú stranu vodiacej lišty papiera k pravému okraju.

- 3 Vložte niekoľko hárkov papiera so stranou tlačie smerujúcou nahor a posuňte bočnú vodiacu lištu papiera oproti okraju stohu papiera.

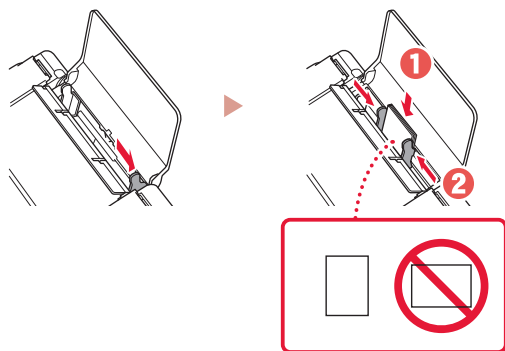

- 4 Stlačte tlačidlo **Výber papiera (Paper Select)**, zvolte veľkosť papiera a potom stlačte tlačidlo **OK**.



- 5 Vysuňte výstupný zásobník papiera.

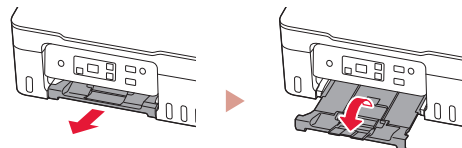

Preprava tlačiarne

Pri premiestňovaní tlačiarne nezabudnite skontrolovať nasledujúce položky. Podrobnosti si pozrite v **Príručka online**.

Skontrolujte, či sú kryty kaziet úplne uzavreté.

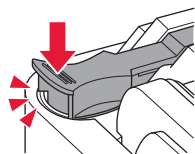

Ak je držiak tlačovej hlavy v strede tlačiarne, skontrolujte, či je kryt zatvorený.

Tlačiareň zabaľte do plastovej tašky, keby z nej náhodou unikol atrament.

- Tlačiareň zabaľte do pevnej škatule tak, aby spodná strana smerovala nadol. Použite dostatočné množstvo ochranného materiálu, ktoré zaručí bezpečnú prepravu.
- Tlačiareň nenakláňajte. Môže dôjsť k priesaku atramentu.
- Buďte opatrný a dbajte na to, aby škatuľa zostala naplocho a NEBOLA otočená zhora nadol alebo na stranu, keďže tlačiareň sa môže poškodiť a atrament v tlačiarňi môže presiaknuť.
- Ak prepravu tlačiarne zabezpečuje prepravná spoločnosť, označte škatuľu nápisom „TOUTO STRANOU NAHOR“, aby sa zaručilo, že spodná strana tlačiarne bude smerovať nadol. Škatuľu označte aj nápisom „KREHKÉ“ alebo „POZOR, SKLO“.

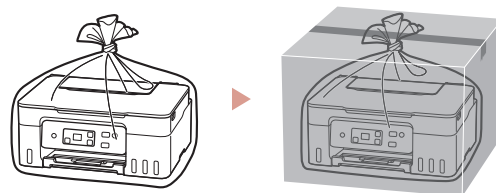

Konfigurowanie drukarki

1. Zawartość opakowania

- Głowice drukujące

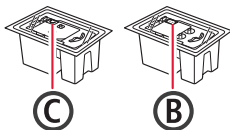

- Butelki z atramentem

- Kabel zasilania

- Instalacyjny dysk CD-ROM

- Informacje o bezpieczeństwie i ważne uwagi

- Pierwsze uruchomienie (ten podręcznik)

2. Włączanie drukarki

- 1 Podłącz kabel zasilania.

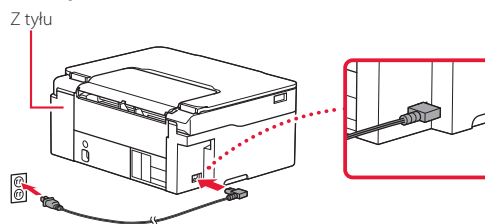

- 2 Naciśnij przycisk **WŁ. (ON)**.

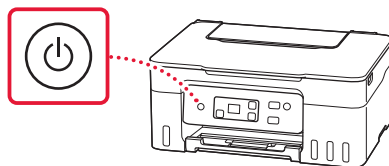

Konfigurowanie drukarki

Łatwa konfiguracja za pomocą komputera



Komputer

Konfiguracja za pomocą
tej instrukcji



Pierwsze uruchomienie

3

Łatwa konfiguracja za pomocą komputera

Na komputerze mogą być wyświetlane proste, łatwe do wykonania instrukcje.

- 1 Aby rozpocząć konfigurację, otwórz poniższy adres URL.

<https://ij.start.canon/G2470>

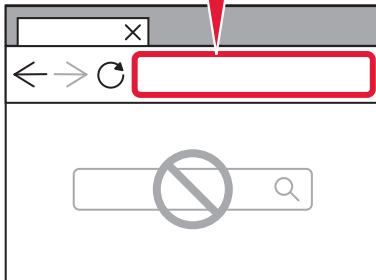

- 2 Aby zakończyć konfigurację i wykonać wydruk, postępuj zgodnie z instrukcjami.

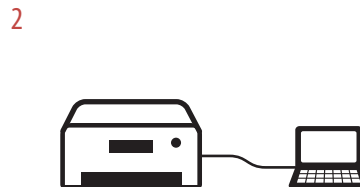
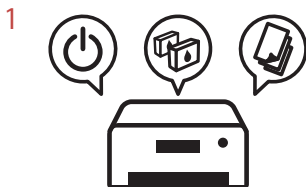

4. Wkładanie głowic drukujących

- 1 Otwórz moduł skanera/pokrywę.

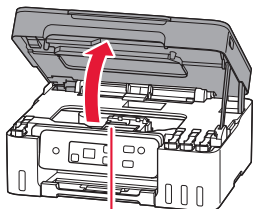

⚠ Przewaga

Nie dotykaj uchwytu głowicy drukującej, dopóki się nie zatrzyma.

- 2 Otwórz pokrywę blokującą głowicy drukującej.

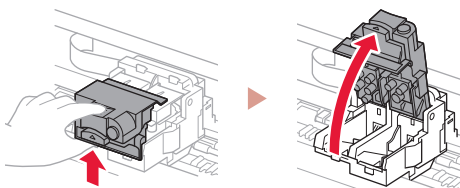

- 3 Wyjmij każdą głowicę drukującą z opakowania i zdejmij etykietę.

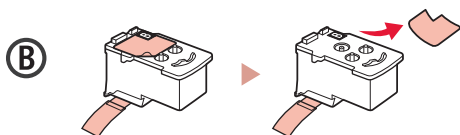
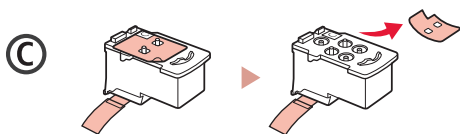

- 4 Usuń pomarańczową taśmę.

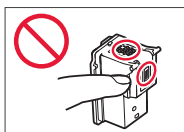
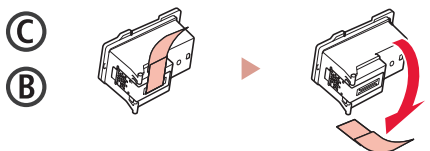

- 5 Włóż głowicę drukującą C (kolorową) po lewej stronie i głowicę drukującą B (czarną) po prawej.

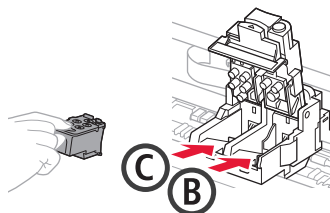

- 6 Zamknij pokrywę blokującą głowicy drukującej i dociśnij ją do kliknięcia.

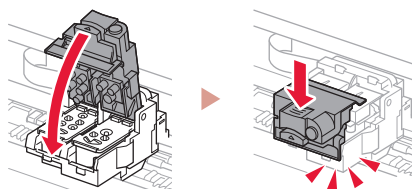

Konfigurowanie drukarki

5. Nalewanie atramentu

Ważne

Ten produkt wymaga ostrożnego obchodzenia się z atramentem. Atrament może rozlać się, jeśli zbiorniki z atramentem są pełne. Jeśli atrament poplamie ubranie, jego zmycie może być niemożliwe.

- 1 Otwórz nasadkę zbiornika po lewej stronie drukarki.

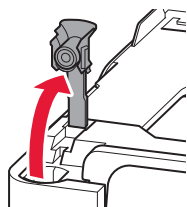

- 2 Ustaw butelkę z atramentem pionowo i delikatnie odkręć zakrętkę butelki.

Sprawdź!

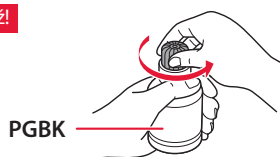

- 3 Dopasuj dyszę butelki z atramentem do wlotu.

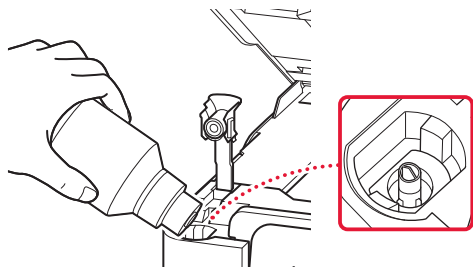

- 4 Powoli postaw butelkę z atramentem do góry nogami i dociśnij ją, aby wlać atrament.

- Jeśli tusz się nie wylewa, zdejmij delikatnie butelkę z atramentem i spróbuj ponownie.

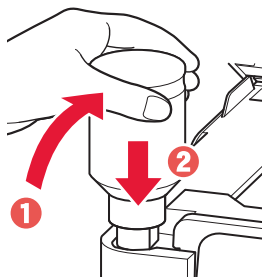

- 5 Delikatnie wyjmij butelkę z atramentem z wlotu.

- Uważaj, aby nie rozlać atramentu.

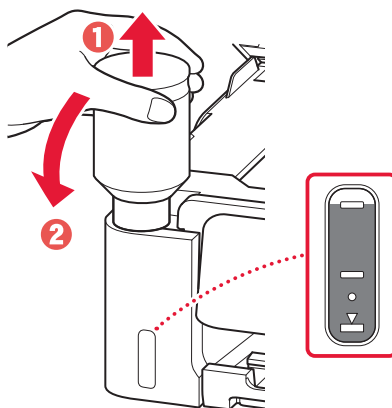

- 6 Dokładnie załóż z powrotem nasadkę zbiornika.

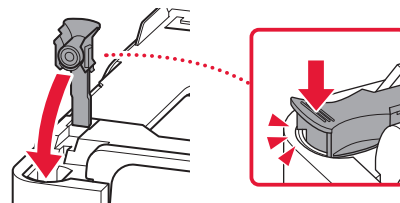

- 7 Powtórz kroki 1 do 6, aby wlać cały atrament do odpowiednich zbiorników z atramentem po prawej stronie.

Sprawdź!

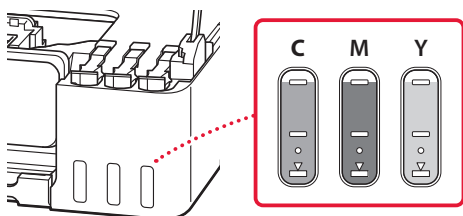

- 8 Zamknij moduł skanera/pokrywę.

- Jeśli lekko podniesiesz moduł skanera/pokrywę i puścisz ją, moduł/pokrywa zamknie się sama.

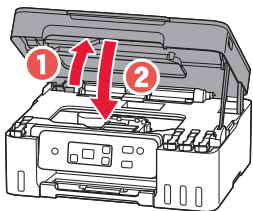

- 9 Gdy pojawi się poniższy ekran, naciśnij przycisk **OK**.



- Rozpoczyna się przygotowywanie systemu atramentu.
Potrwa to około 6 minut. Po zakończeniu zostanie wyświetlony poniższy ekran.



Wybierz sposób podłączenia optymalnie pasujący do sposobu używania drukarki.

- **Używanie drukarki bez podłączenia do niej żadnych urządzeń**
 - ➔ Konfiguracja jest ukończona.
- **Aby użyć drukarki połączonej z komputerem**
 - ➔ Przejdź do następnej strony.



Gdy pojawi się dowolny z poniższych ekranów



Cyfry lub litery

Przeczytaj zawartość ekranu i wykonaj odpowiednie instrukcje poniżej.

E04

Główki drukujące nie są poprawnie zainstalowane.

- ➔ „4. Wkładanie głowic drukujących” na stronie 3

E05

Nie można rozpoznać głowic drukujących.

- ➔ „4. Wkładanie głowic drukujących” na stronie 3

W pozostałych przypadkach wybierz opcję **Podręcznik online**.

6. Łączenie z komputerem



Jeśli korzystasz z wielu komputerów, wykonaj te kroki na każdym z nich.

- 1 Otwórz bezpośredni stronę Canon. Nie trzeba jej wyszukiwać.

<https://ij.start.canon/connect>

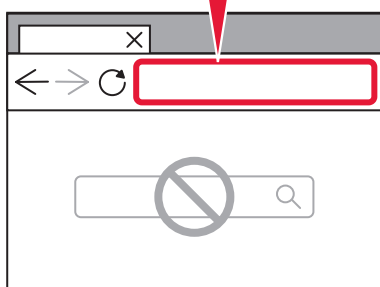

- 2 Wprowadź nazwę modelu drukarki i kliknij opcję **Przejdź**.
- 3 Postępuj zgodnie z instrukcjami wyświetlanymi na ekranie.

Używanie instalacyjnego dysku CD-ROM

1. Na wyświetlonym ekranie kliknij dwukrotnie przycisk **EasySetup.exe**.
2. Jeśli pojawi się ekran wyboru drukarki, wybierz opcję **G2470**.
Jeśli zostanie wyświetlony ekran instalacji, kliknij opcję **Dalej (Next)**.
3. Postępuj zgodnie z instrukcjami wyświetlanymi na ekranie.

Jeśli nic się nie pojawi, uruchom Eksploratora (Explorer) i uruchom plik **EasySetup.exe** z płyty CD.

Ładowanie papieru

- 1 Otwórz podpórkę papieru.

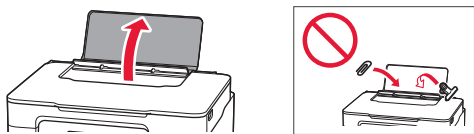

- 2 Przesuń prawą prowadnicę papieru maksymalnie w prawo.

- 3 Włóż kilka arkuszy papieru o odpowiednim rozmiarze stroną do zadrukowania skierowaną do góry i dosuń prowadnicę papieru do krawędzi arkuszy.

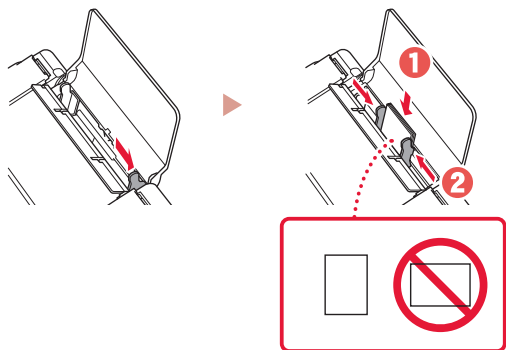

- 4 Naciśnij przycisk **Wybierz papier (Paper Select)**, wybierz rozmiar papieru i naciśnij przycisk **OK**.



- 5 Wysuń tacę wyprowadzania papieru.

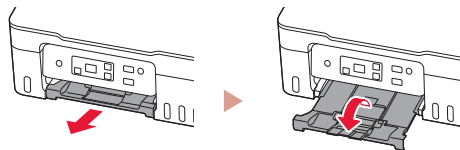

Transportowanie drukarki

Przestawiając drukarkę w inne miejsce, sprawdź poniższe elementy. Szczegóły — zobacz **Podręcznik online**.

Sprawdzić, czy nasadki zbiornika są całkowicie zamknięte.

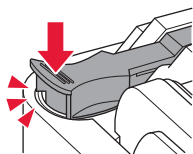

Jeśli uchwyt głowicy drukującej jest ustawiony na środku drukarki, sprawdź, czy pokrywa jest zamknięta.

Włóż drukarkę do plastikowej torby na wypadek wycieku atramentu.

- Zapakuj drukarkę do solidnego pudełka spodem do dołu, używając wystarczającej ilości materiału ochronnego, która zapewni bezpieczny transport.
- Nie przechylaj drukarki. Atrament może wyciec.
- Obchodź się z pudełkiem ostrożnie i upewnij się, że pudełko będzie leżeć płasko oraz NIE zostanie ustawione do góry nogami ani na boku, ponieważ mogłoby to spowodować uszkodzenie drukarki i wyciek atramentu.
- Jeśli transportem drukarki zajmuje się firma spedycyjna, należy poprosić o oznaczenie pudła napisem „TAJ STRONĄ DO GÓRY”, aby drukarka znajdowała się cały czas w pozycji spodem do dołu. Oznacz pudełko także oznaczeniami „OSTROŻNIE”.

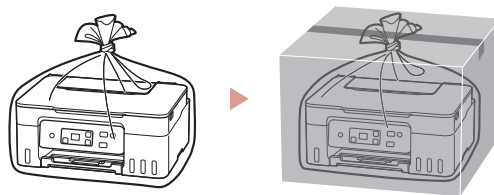

A nyomtató beüzemelése

1. A doboz tartalma

- Nyomtatófejek

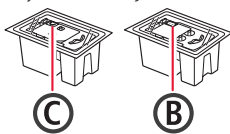

- Tintaflakonok

- Tápkábel

- Telepítő CD-ROM

- Biztonsági és fontos tudnivalók

- Beüzemelési útmutató (ez a kézikönyv)

2. A nyomtató bekapcsolása

- 1 Csatlakoztassa a tápkábelt.

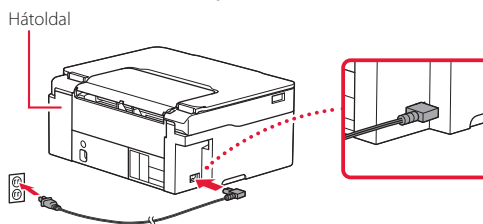

- 2 Nyomja meg a **BE (ON)** gombot.

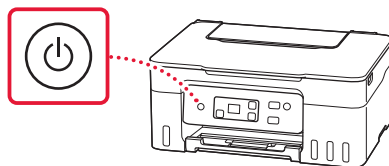

A nyomtató beüzemelése

Egyszerű beállítás számítógép használatával



Számítógép

Beállítás a kézikönyv segítségével



Beüzemelési útmutató

3

Egyszerű beállítás számítógép használatával

Egyszerű, könnyen követhető utasítások jelennek meg számítógépén.

- 1 A beállítás megkezdéséhez keresse fel az alábbi weboldalt.

<https://ij.start.canon/G2470>

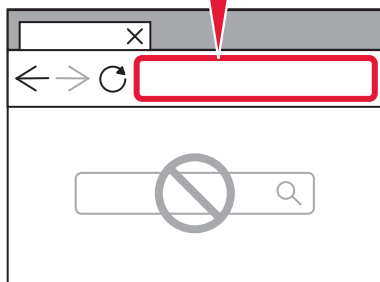

- 2 Kövesse az utasításokat a beállítás befejezéséhez és a nyomtatáshoz.

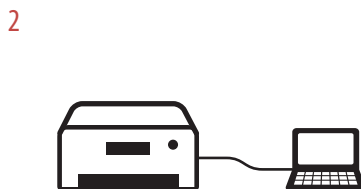
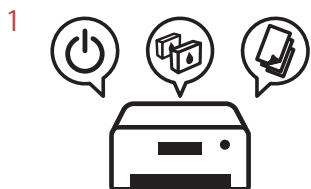

4. A nyomtatófejek behelyezése

- 1 Nyissa fel a lapolvasó egységet/fedelet.

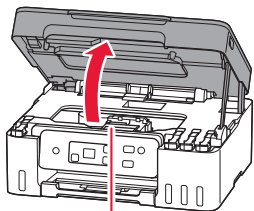

▲ Figyelem

Amíg meg nem áll, ne érjen hozzá a nyomtatófej tartójához!

- 2 Nyissa fel a nyomtatófej zárófedelét.

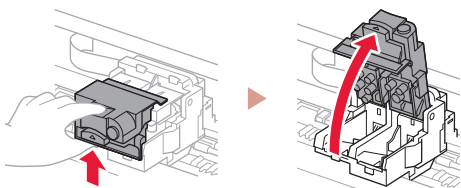

- 3 Vegye ki mindegyik nyomtatófejet a csomagból, és távolítsa el a címkéjét.

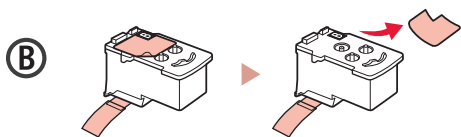
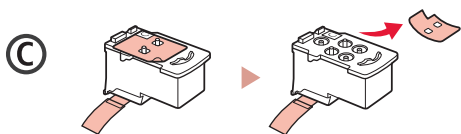

- 4 Távolítsa el a narancssárga szalagot.

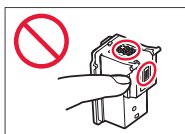
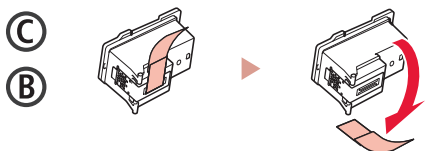

- 5 Tegye be a C (színes) nyomtatófejet a bal oldalra, a B (fekete) nyomtatófejet pedig a jobb oldalra.

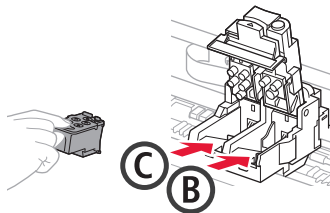

- 6 Csukja le a nyomtatófej zárófedelét, és kattanasig nyomja le.

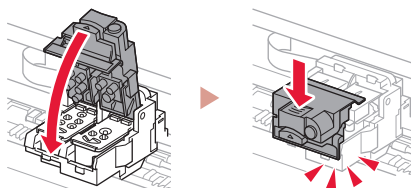

A nyomtató beüzemelése

5. A tinta betöltése

Fontos

E termék esetén óvatosan kell bánni a tintával. Amikor a tintatartályok tele vannak tintával, a tinta kifolyhat. Ha a tinta a ruhájára vagy egyéb holmijára kerül, előfordulhat, hogy a folt nem távolítható el.

1 A nyomtató bal oldalán nyissa ki a tartálysapkát.

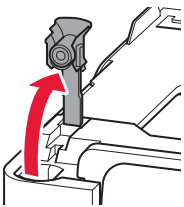

2 Tartsa függőlegesen a tintaflakont, és óvatosan csavarja le a flakon sapkáját.

Ellenőrizze!

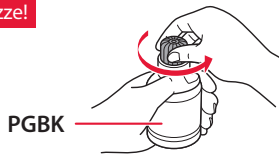

3 Illessze a tintaflakon kiöntőcsövét a bemenetbe.

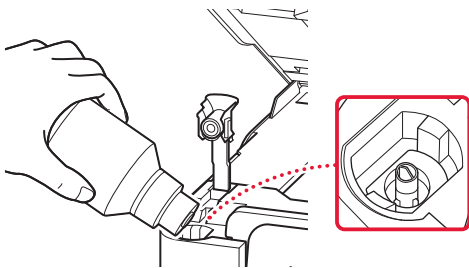

4 Lassan fordítsa fel a tintaflakont, és nyomja le, hogy befolyhasson a tinta.

- Ha nem folyik a tinta, akkor óvatosan vegye el a tintaflakont, és próbálja meg újra.

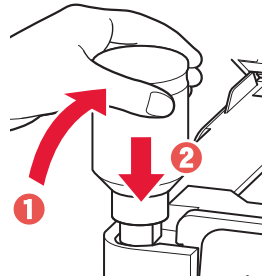

5 Óvatosan vegye el a tintaflakont a bemenettől.

- Vigyázzon, nehogy kimenjen a tinta!

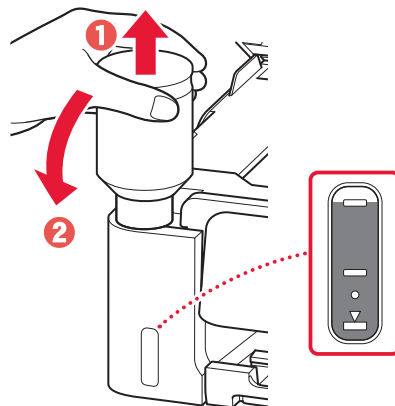

6 Tegye vissza megfelelően a tartálysapkát.

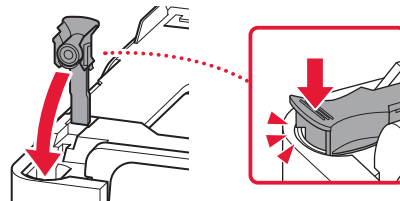

- 7 Az 1–6. lépéseket megismételve öntse bele az összes tintát a jobb oldalon található megfelelő tintatartályokba.

Ellenőrizze!

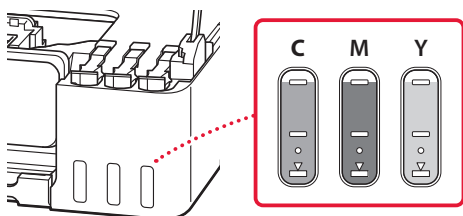

- 8 Csukja le a lapolvasó egységet/fedelet.

- Ha kissé megemeli a lapolvasó egységet/fedelet, és elengedi, az magától becsukódik.

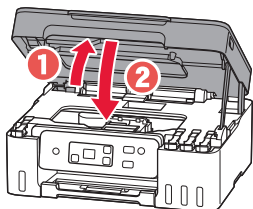

- 9 Amikor megjelenik a következő képernyő, nyomja meg az **OK** gombot.



- Megkezdődik a tintarendszer előkészítése. Ez körülbelül 6 percet vesz igénybe. Amikor befejeződött, megjelenik a következő képernyő.



Válassza ki azt a csatlakoztatási módszert, amely a leginkább megfelel annak, ahogyan a nyomtatót használni fogja.

- Ha a nyomtatót más eszközhöz történő csatlakoztatás nélkül szeretné használni
 - ➔ Befejeződött az üzembe helyezés.
- Ha a nyomtatót számítógéphez csatlakoztatva szeretné használni
 - ➔ Folytassa a következő oldalon.



Ha a következő képernyők egyike jelenik meg



Számok vagy betűk

Nézze meg a képernyőt, és kövesse az alábbi megfelelő utasításokat.

E04

Nincsenek megfelelően betéve a nyomtatófejek.

- ➔ „4. A nyomtatófejek behelyezése”, 3. oldal

E05

Nem ismerhetők fel a nyomtatófejek.

- ➔ „4. A nyomtatófejek behelyezése”, 3. oldal

Minden egyéb esetben kövesse az **Online kézikönyv** útmutatásait.

6. Csatlakoztatás számítógéphez



Ha több számítógépet használ, akkor a következő lépéseket mindegyik számítógépen hajtsa végre.

- 1 Keresse fel közvetlenül a Canon weboldalát. Nem kell keresést végezni.

<https://ij.start.canon/connect>

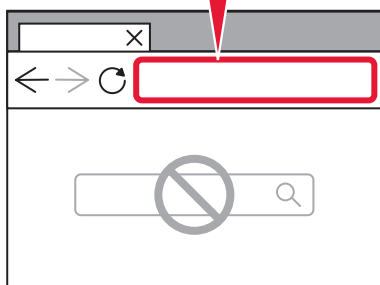

- 2 Írja be a nyomtató modellnevét, és kattintson az **Ugrás** gombra.
- 3 Kövesse a képernyőn megjelenő utasításokat.

Telepítő CD-ROM használata

1. Kattintson duplán a képernyőn megjelenő **EasySetup.exe** elemre.
2. Ha megjelenik a nyomtatóválasztó képernyő, válassza a **G2470** lehetőséget.
Ha megjelenik a telepítési képernyő, kattintson a **Tovább (Next)** gombra.
3. Kövesse a képernyőn megjelenő utasításokat.

Ha semmi sem jelenik meg, nyissa meg az Explorert (Explorer), majd futtassa az **EasySetup.exe** fájlt a CD-ROM-ról.

Papír betöltése

1 Nyissa ki a papírtámaszt.

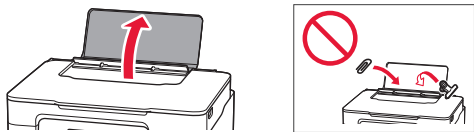

2 Tolja a jobb oldali papírvezetőt a jobb szélső helyzetbe.

3 Tegyen be néhány papírlapot úgy, hogy nyomtatási oldala felfelé nézzen, és tolja a papírvezetőt a papírköteg oldalához.

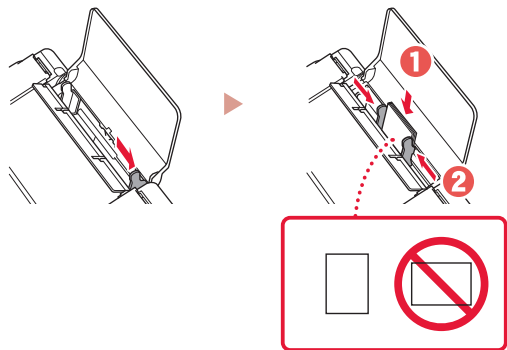

4 Nyomja meg a **Papír kiválasztása (Paper Select)** gombot, válasszon ki egy papírméretet, majd nyomja meg az **OK** gombot.

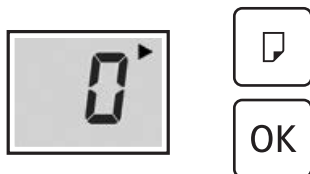

5 Húzza ki a papírgyűjtő tálcat.

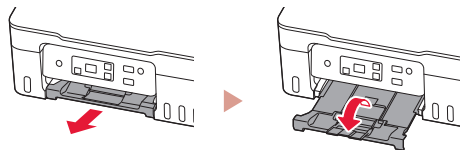

A nyomtató szállítása

Amikor szállítja a nyomtatót, ellenőrizze a következőket. A részleteket az **Online kézikönyv** tartalmazza.

Ellenőrizze, hogy a tartálysapkák teljesen zárva vannak-e.

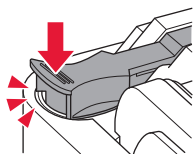

Ha a nyomtatófej tartója a nyomtató közepén van, ellenőrizze, hogy a fedél zárva van-e.

Ha szivárog a tinta, a nyomtatót tegye műanyagzsákba.

- Csomagolja a nyomtatót egy erős dobozba úgy, hogy a nyomtató alsó fele nézzen lefelé; gondoskodjon a biztonságos szállításhoz szükséges elegendő védőanyagról.
- Ne döntse meg a nyomtatót, mert kifolyhat a tinta!
- Óvatosan bánjon vele, és ügyeljen arra, hogy a doboz vízszintes maradjon és NE forduljon fel vagy az oldalára, mert tönkremehet a nyomtató és kifolyhat a tinta a nyomtatóban.
- Ha egy szállítócég végzi a nyomtató szállítását, jelölje meg a nyomtató dobozát „EZ A FELSŐ OLDAL” felirattal, hogy mindig a nyomtató alsó fele nézzen lefelé. Helyezze el a „TÖRÉKENY” vagy az „ÓVATOSAN KEZELENDŐ” feliratot is.

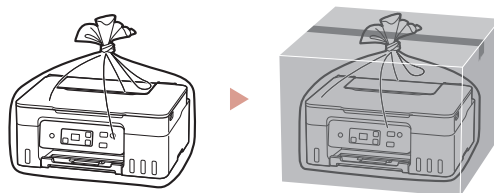

Yazıcı Kurulumu

1. Kutu İçeriği

- Yazıcı Kafaları

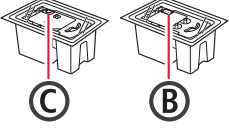

- Mürekkep Şişeleri
- Güç Kablosu
- Kurulum CD-ROM'u
- Güvenlik ve Önemli Bilgiler
- Başlangıç Kılavuzu (bu el kitabı)

2. Yazıcıyı Açma

- 1 Güç kablosunu takın.

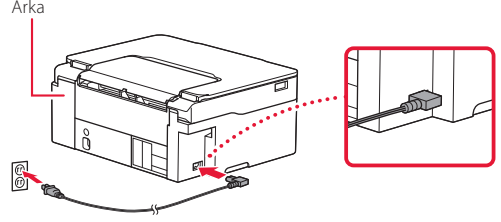

- 2 Açma (ON) düğmesine basın.

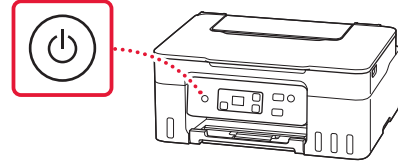

Bilgisayar Kullanarak Kolay Kurulum



Bilgisayar

Bu Kılavuzu Kullanarak Kurulum



Başlangıç Kılavuzu

3

Bilgisayar Kullanarak Kolay Kurulum

Bilgisayarınızda basit ve izlemesi kolay yönergeler görüntülenir.

- 1 Kurulumu başlatmak için aşağıdaki URL'yi ziyaret edin.

<https://ij.start.canon/G2470>

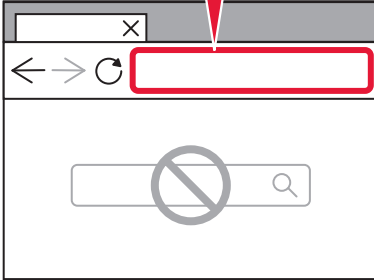

- 2 Kurulumu tamamlamak ve yazdırmak için yönergeleri izleyin.

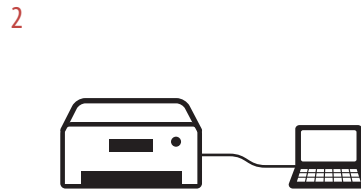
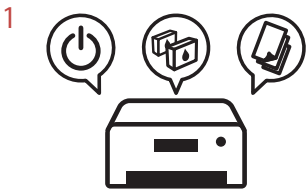

4. Yazıcı Kafalarını Takma

- 1 Tarama birimini / kapağını açın.

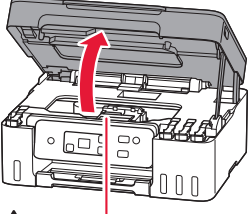

⚠ Dikkat

Durana kadar yazıcı kafası muhafazasına dokunmayın.

- 2 Yazıcı kafası kilitleme kapağını açın.

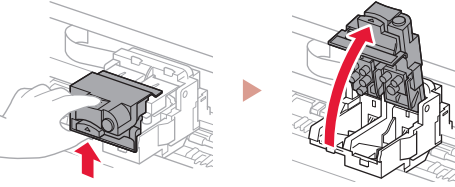

- 3 Her bir yazıcı kafasını paketten çıkarın ve etiketi kaldırın.

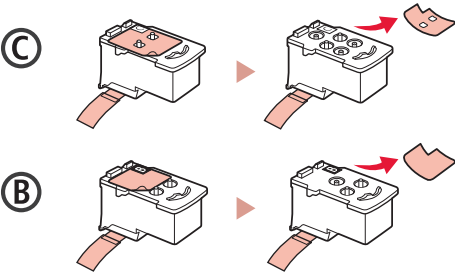

- 4 Turuncu bandı çıkarın.

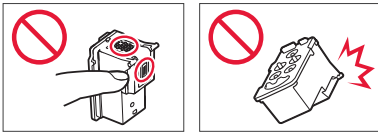
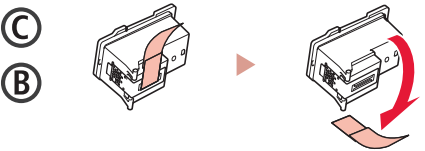

- 5 Soldaki C (renkli) yazıcı kafasını ve sağdaki B (siyah) yazıcı kafasını takın.

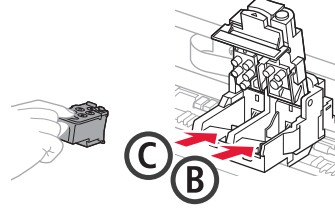

- 6 Yazıcı kafası kilitleme kapağını kapatın ve tık sesiyle yerine oturana kadar aşağı doğru bastırın.

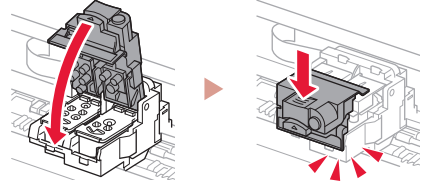

5. Mürekkebi Dökme

►►► Önemli

Bu ürün, mürekkebin dikkatli bir şekilde kullanılmasını gerektirir. Mürekkep kutuları mürekkeple doldurulduğunda mürekkep sıçrayabilir. Mürekkep elbiselerinize veya eşyalarınıza bulaşırsa çıkmayabilir.

- 1 Yazıcının solundaki kutu kapağını açın.

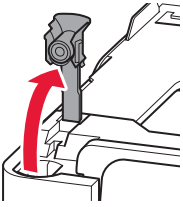

- 2 Mürekkep şişesini dik tutun ve şişe kapağını yavaşça çevirerek çıkarın.

Kontrol edin!

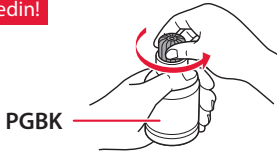

- 3 Mürekkep şişesinin püskürtme ucunu giriş ile hizalayın.

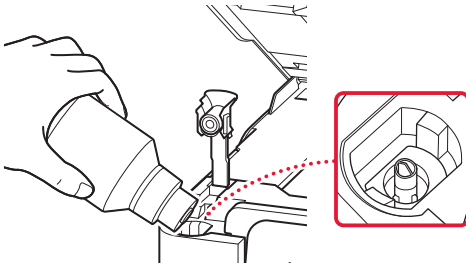

- 4 Mürekkep şişesini yavaşça baş aşağı çevirin ve mürekkebi dökmek için bastırın.

- Mürekkep dökülmezse, mürekkep şişesini yavaşça çıkarın ve tekrar deneyin.

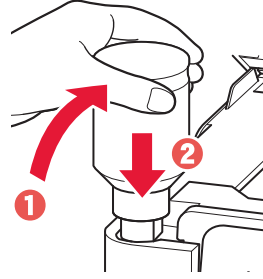

- 5 Mürekkep şişesini girişten yavaşça çıkarın.

- Mürekkebi dökmemeye özen gösterin.

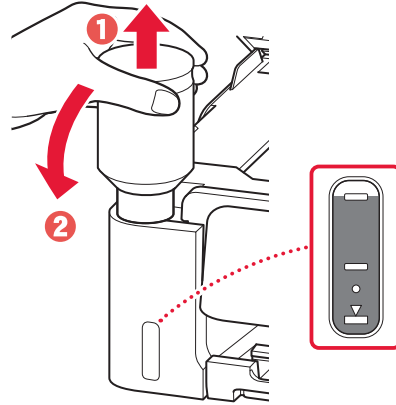

- 6 Kutu kapağını **emniyetli bir şekilde** yerine geri takın.

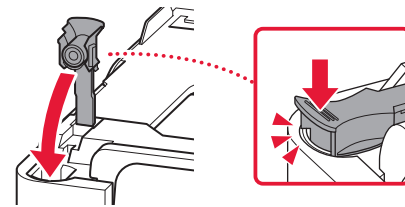

7 1 – 6 arası adımları tekrarlayarak tüm mürekkebi sağdaki ilgili mürekkep kutularına dökün.

Kontrol edin!

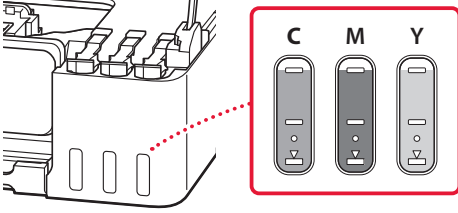

8 Tarama birimini / kapağı kapatın.

- Tarama birimini / kapağını hafifçe kaldırıp bırakırsanız, kendi kendine kapanacaktır.

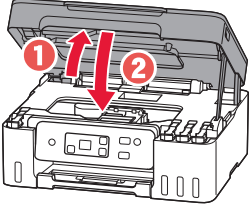

9 Aşağıdaki ekran görüntülediğinde **OK** düğmesine basın.



- Mürekkep sistemi hazırlığı başlar. Bu işlem yaklaşık 6 dakika alır. Tamamlandıktan sonra aşağıdaki ekran görüntülenir.



Yazıcıyı nasıl kullanacağınıza en uygun bağlantı yöntemini seçin.

- Diğer aygıtları bağlamadan yazıcıyı kullanmak için
 - ➔ Kurulum şimdi tamamlandı.
- Yazıcıyı bilgisayara bağlayarak kullanmak için
 - ➔ Bir sonraki sayfaya geçin.



Aşağıdaki ekranlardan biri görüntülenirse



Sayılar veya harfler

Ekrana bakın ve ardından aşağıdaki ilgili yönergeleri izleyin.

E04

Yazıcı kafaları doğru takılmamış.

- ➔ "4. Yazıcı Kafalarını Takma", sayfa 3

E05

Yazıcı kafaları tanınmıyor.

- ➔ "4. Yazıcı Kafalarını Takma", sayfa 3

Diğer tüm durumlar için bkz. **Çevrimiçi El Kitabı**.

6. Bilgisayara Bağlanma



Birden fazla bilgisayar kullanıyorsanız her bilgisayarda bu adımları gerçekleştirin.

- 1 Canon web sitesine doğrudan erişin. Arama yapmanıza gerek yok.

<https://ij.start.canon/connect>

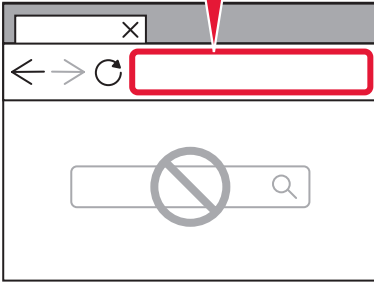

- 2 Yazıcınızın model adını girin ve **Git** ögesine tıklayın.
- 3 Ekrandaki yönergeleri izleyin.

Kurulum CD-ROM'unu Kullanma

1. Görüntülenen ekranda **EasySetup.exe** ögesine çift tıklayın.
2. Yazıcı seçim ekranı görüntülenirse, **G2470** ögesini seçin.
Yükleme ekranı görüntülenirse, **İleri (Next)** ögesine tıklayın.
3. Ekrandaki yönergeleri izleyin.

Hiçbir şey görüntülenmezse, Gezgin'i (Explorer) başlatın ve CD-ROM'da **EasySetup.exe** ögesini çalıştırın.

Kağıt Yerleştirme

1 Kağıt desteğini açın.

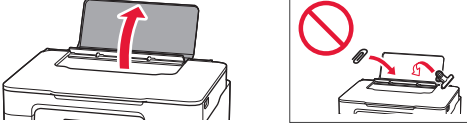

2 Sağ taraftaki kağıt kılavuzunu en sağa kaydırın.

3 Birkaç sayfa kağıdı, yazdırılacak tarafı yukarı bakacak şekilde yükleyin ve yan kağıt kılavuzunu kaydırarak kağıt destesinin kenarına temas ettirin.

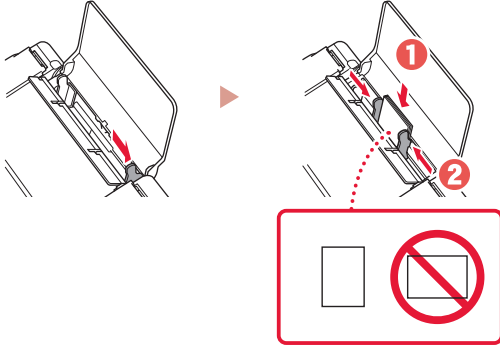

4 **Kağıt Seçimi (Paper Select)** düğmesine basın, kağıt boyutunu seçin ve ardından **OK** düğmesine basın.



5 Kağıt çıkış tepsinini uzatın.

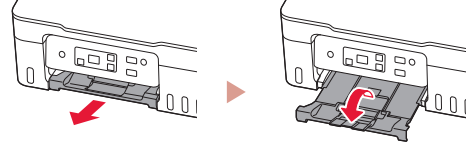

Yazıcınızı Taşıma

Yazıcıyı başka bir yere taşırken aşağıdakileri kontrol edin. Ayrıntılar için **Çevrimiçi El Kitabı** dokümanına bakın.

Kutu kapaklarının tamamen kapalı olup olmadığını kontrol edin.

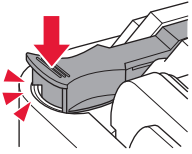

Yazıcı kafası muhafazası yazıcının ortasındaysa, kapağın kapalı olduğunu kontrol edin.

Mürekkep akıyorsa, yazıcıyı plastik bir poşetle paketleyin.

- Güvenli taşınması için yazıcıyı alt tarafı aşağı bakacak şekilde sağlam bir kutuya koyun ve yeterli miktarda koruyucu malzeme kullanın.
- Yazıcıyı eğmeyin. Mürekkep sızabilir.
- Lütfen dikkatli bir şekilde taşıyın ve kutunun düz tutulduğundan ve baş aşağı veya yana doğru çevrilmediğinden emin olun; aksi halde yazıcı hasar görebilir ve yazıcıdaki mürekkep sızabilir.
- Taşıma görevlisi yazıcıyı taşırken, kutunun üst tarafına "ÜST TARAF" yazıldığından emin olun, bu sayede yazıcının alt tarafı üste gelecek şekilde konmadığından emin olabilirsiniz. Ayrıca "KIRILACAK EŞYA" veya "DİKKATLİ TAŞIYIN" yazın.

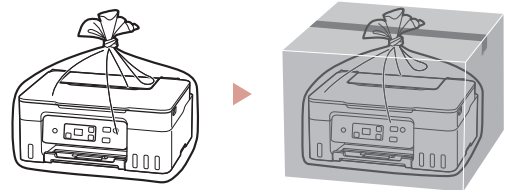

Configurarea imprimantei

1. Conținutul cutiei

- Capete de imprimare

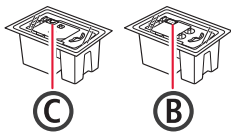

- Sticle de cerneală
- Cablu de alimentare
- CD-ROM de instalare
- Informații cu privire la siguranță și alte informații importante
- Ghid de inițiere (acest manual)

2. Pornirea imprimantei

- 1 Conectați cablul de alimentare.

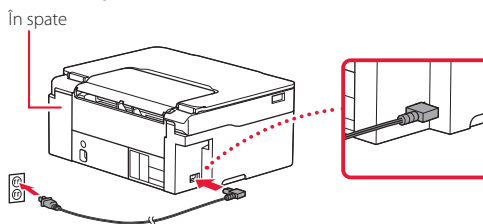

- 2 Apăsați butonul **ACTIVARE (ON)**.

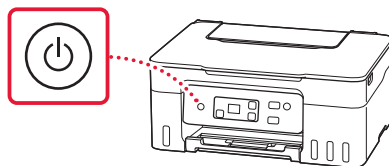

Configurarea imprimantei

Configurare simplă utilizând computerul



Computer

Configurare utilizând acest manual



Ghid de inițiere

3

Configurare simplă utilizând computerul

Instrucțiuni simple și ușor de urmat sunt afișate pe computer.

- 1 Accesați adresa URL de mai jos pentru a începe configurarea.

<https://ij.start.canon/G2470>

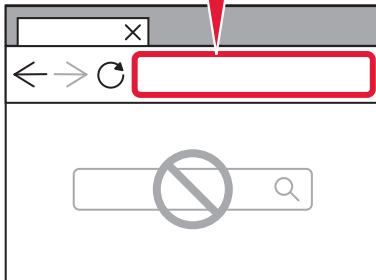

- 2 Urmați instrucțiunile pentru a finaliza configurarea și a imprima.

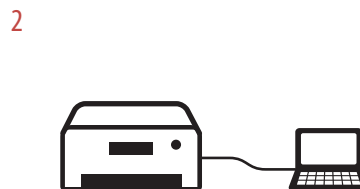

4. Instalarea capetelor de imprimare

- 1 Deschideți unitatea de scanare / capacul.

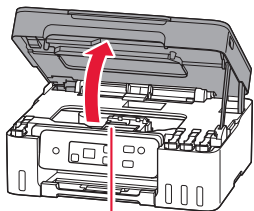

⚠ Atenție

Nu atingeți suportul capului de imprimare până când acesta nu se oprește din mișcare.

- 2 Deschideți capacul de blocare a capului de imprimare.

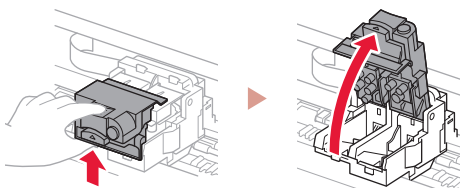

- 3 Scoateți fiecare cap de imprimare din ambalaj și îndepărtați eticheta.

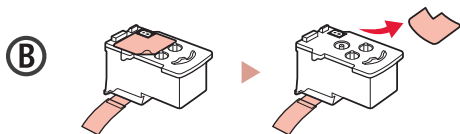
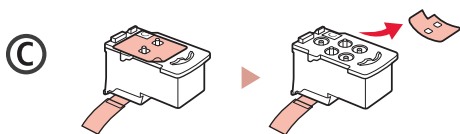

- 4 Îndepărtați banda portocalie.

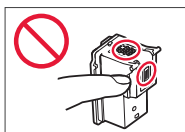
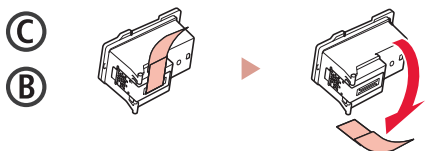

- 5 Introduceți capul de imprimare C (color) în partea stângă și capul de imprimare B (negru) în partea dreaptă.

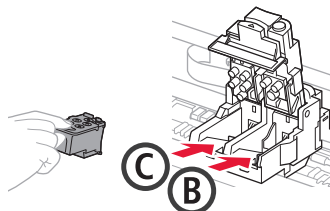

- 6 Închideți capacul de blocare a capului de imprimare și împingeți în jos până când se aude un clic.

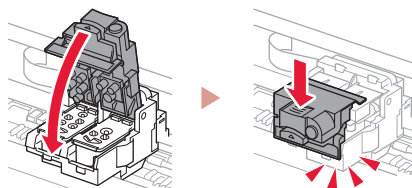

Configurarea imprimantei

5. Turnarea cernelii

►►► Important

Pentru acest produs, este necesară manipularea atentă a cernelii. Pot sări stropi de cerneală când rezervoarele de cerneală sunt umplute. Dacă vă stropiți cu cerneală pe haine sau pe alte lucruri, este posibil ca petele să nu mai iasă.

- 1 Deschideți capacul rezervorului din partea stângă a imprimantei.

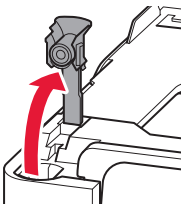

- 2 Țineți sticla de cerneală în poziție verticală și răsuciți ușor capacul sticlei pentru a-l scoate.

Verificați!

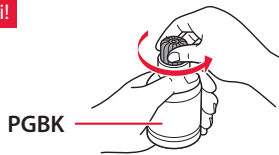

- 3 Aliniați duza sticlei de cerneală cu orificiul de umplere.

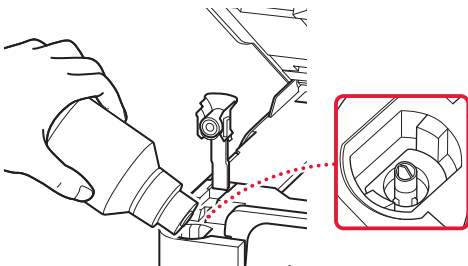

- 4 Răsturnați ușor sticla de cerneală și împingeți în jos pentru a turna cerneala.

- Dacă cerneala nu curge, îndepărtați ușor sticla de cerneală și încercați din nou.

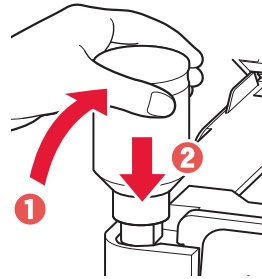

- 5 Scoateți ușor sticla de cerneală din orificiul de umplere.

- Aveți grijă să nu vărsați cerneala.

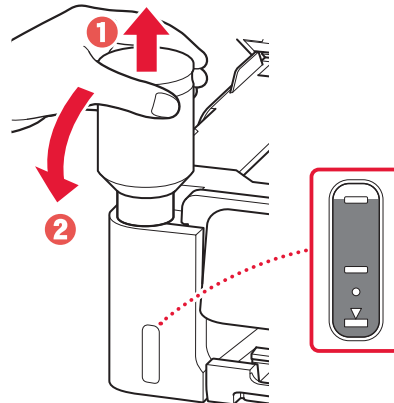

- 6 Așezați la loc în siguranță capacul rezervorului.

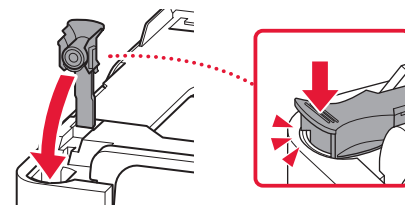

- 7 Repetați pașii de la 1 până la 6 pentru a turna toată cerneala în rezervoarele de cerneală corespunzătoare din partea dreaptă.

Verificați!

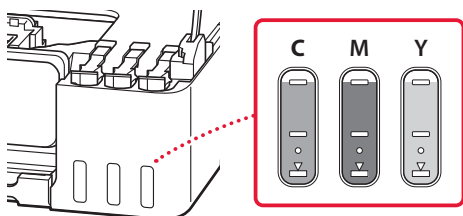

- 8 Închideți unitatea de scanare / capacul.

- Dacă ridicați ușor unitatea de scanare / capacul și îl eliberați, se va închide singur.

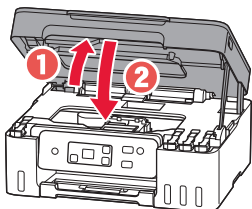

- 9 Când apare următorul ecran, apăsați butonul **OK**.



- Începe pregătirea sistemului de cerneală. Aceasta durează aproximativ 6 minute. Odată finalizată, apare următorul ecran.



Selectați metoda de conectare care se potrivește cel mai bine cu modul în care veți utiliza imprimanta.

- Pentru a utiliza imprimanta fără a o conecta la alte dispozitive
 - ➔ Configurarea este acum finalizată.
- Pentru a utiliza imprimanta prin conectarea la un computer
 - ➔ Continuați la pagina următoare.



Dacă apare unul din ecranele următoare



Numere sau litere

Verificați ecranul, apoi urmați instrucțiunile corespunzătoare de mai jos.

E04

Capetele de imprimare nu sunt instalate corect.

- ➔ „4. Instalarea capetelor de imprimare” la pagina 3

E05

Capetele de imprimare nu pot fi recunoscute.

- ➔ „4. Instalarea capetelor de imprimare” la pagina 3

Pentru toate celelalte situații, consultați **Manual online**.

6. Conectarea la un computer



Dacă folosiți mai multe computere, efectuați pașii următori pe fiecare computer.

- 1 Accesați direct site-ul web Canon. Nu este nevoie să căutați.

<https://ij.start.canon/connect>

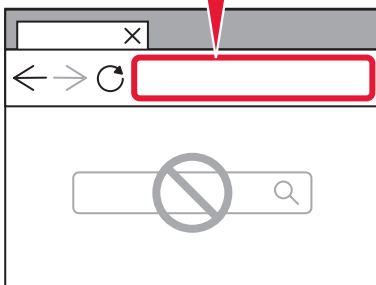

- 2 Introduceți numele modelului imprimantei dvs. și faceți clic pe **Accesați**.
- 3 Urmăți instrucțiunile de pe ecran.

Utilizarea CD-ROM-ului de instalare

1. Pe ecranul care apare, faceți dublu clic pe **EasySetup.exe**.
2. Dacă apare ecranul de selectare a imprimantei, selectați **G2470**.
Dacă apare ecranul de instalare, faceți clic pe **Următor (Next)**.
3. Urmăți instrucțiunile de pe ecran.

Dacă nu apare nimic, porniți Explorator (Explorer), apoi executați **EasySetup.exe** de pe CD-ROM.

Încărcarea hârtiei

- 1 Deschideți suportul pentru hârtie.

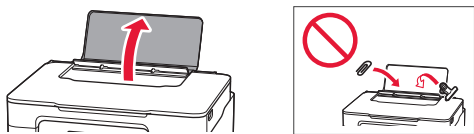

- 2 Glisați ghidajul pentru hârtie din dreapta complet la dreapta.

- 3 Încărcați mai multe coli de hârtie cu fața de imprimare orientată în sus și glisați ghidajul pentru hârtie lateral spre marginea stivei de hârtie.

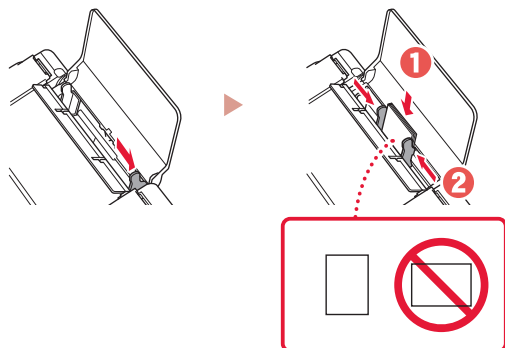

- 4 Apăsați butonul **Selectare hârtie (Paper Select)**, selectați o dimensiune de hârtie, apoi apăsați butonul **OK**.



- 5 Extindeți tava de ieșire a hârtiei.

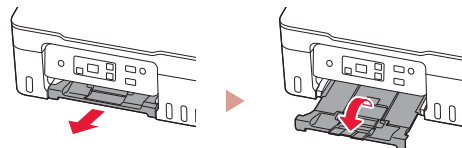

Transportul imprimantei

Când schimbați locul imprimantei, verificați următoarele aspecte. Pentru detalii, consultați **Manual online**.

Verificați dacă sunt închise complet capacele rezervoarelor.

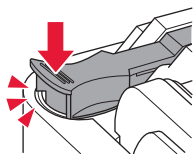

Dacă suportul capului de imprimare se află în centrul imprimantei, verificați dacă este închis capacul.

În cazul în care există scurgeri de cerneală, împachetați imprimanta într-o pungă de plastic.

- Ambalați imprimanta într-o cutie solidă astfel încât să fie așezată cu baza în jos, utilizând material de protecție suficient pentru a asigura transportul în siguranță.
- Nu înclinați imprimanta. Se poate scurge cerneală.
- Manevrați cu grijă și asigurați-vă că cutia rămâne plană și NU întoarsă cu fața în jos sau pe laterale, deoarece imprimanta se poate deteriora și cerneala din imprimantă se poate scurge.
- Când un agent de livrări manevrează transportul imprimantei, cutia acesteia trebuie să fie marcată „CU PARTEA ACEASTA ÎN SUS” pentru a menține imprimanta cu baza în jos. De asemenea, marcați cu „FRAGIL” sau „MANEVRAȚI CU ATENȚIE”.

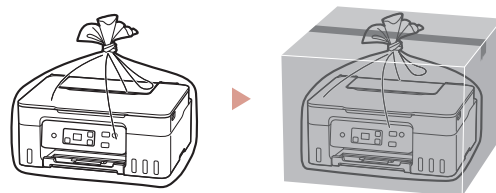

Настройване на принтера

1. Съдържание на комплекта

- Печатащи глави

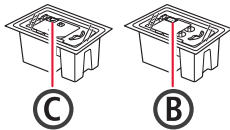

- Бутилки с мастило
- Захранващ кабел
- Инсталационен компактдиск
- Информация за безопасността и важна информация
- Ръководство за начално запознаване (това ръководство)

2. Включване на принтера

1. Свържете захранващия кабел.

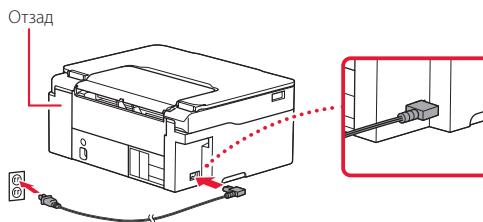

2. Натиснете бутона **Включване (ON)**.

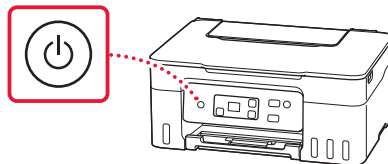

Настройване на принтера

Лесна настройка с помощта на компютър



Компютър

Настройка с помощта на това ръководство



Ръководство за
начално запознаване

3

Лесна настройка с помощта на компютър

Прости и лесни за следване инструкции се показват на вашия компютър.

- 1 Посетете URL адреса по-долу, за да започнете настройката.

<https://ij.start.canon/G2470>

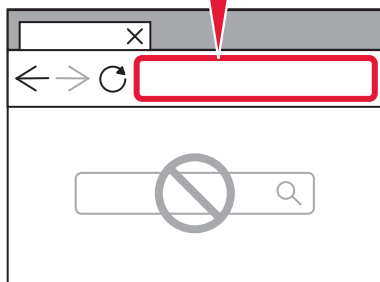

- 2 Следвайте инструкциите, за да завършите настройката и да отпечатате.

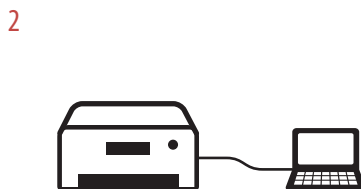
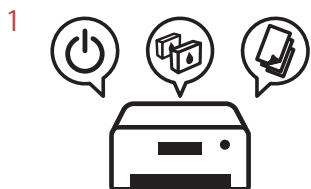

4. Поставяне на печатащите глави

- 1 Отворете сканиращия модул/капака.

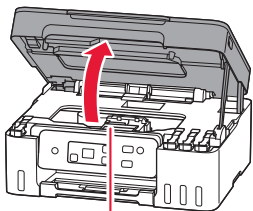

⚠ Внимание

Не докосвайте носача на печатащата глава, докато не спре да се движи.

- 2 Отворете застопоряващия капак на печатащата глава.

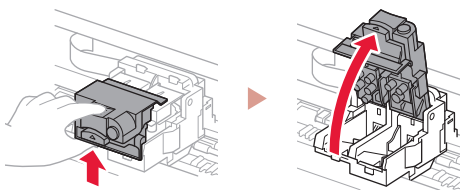

- 3 Извадете всяка от печатащите глави от опаковката и отстранете етикета.

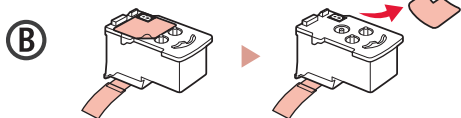
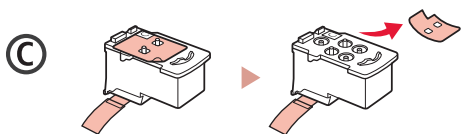

- 4 Отстранете оранжевата лепенка.

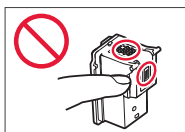
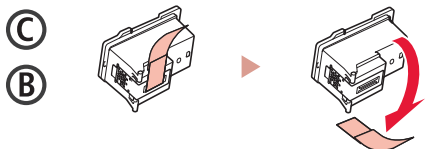

- 5 Поставете печатащата глава С (цветна) отляво и печатащата глава В (черна) отдясно.

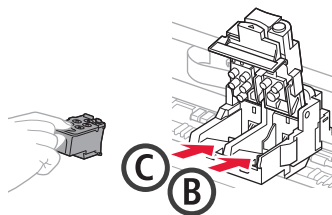

- 6 Затворете застопоряващия капак на печатащата глава и натиснете надолу, докато щракне.

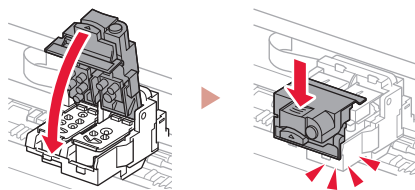

Настройване на принтера

5. Наливане на мастило

Важно

Този продукт изисква внимателно боравене с мастилото. То може да се разпръска при напълване на резервоарите за мастило. Ако по дрехите или вещите ви попадне мастило, може да не се изчисти.

- 1 Отворете капачката на резервоара отляво на принтера.

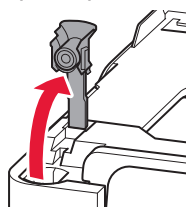

- 2 Дръжте бутилката с мастило изправена и внимателно завъртете капачката на бутилката, за да я свалите.

Проверете!

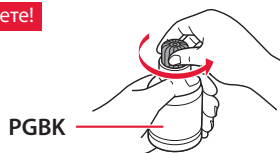

- 3 Подравнете накрайника на бутилката с мастило към входния отвор.

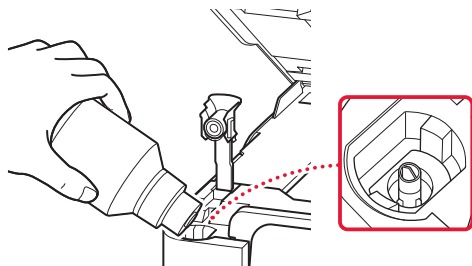

- 4 Бавно обърнете обратно и изправете бутилката с мастило, след което я натиснете надолу, за да налеете мастилото.

- Ако мастилото не се налива, внимателно извадете бутилката с мастило и опитайте отново.

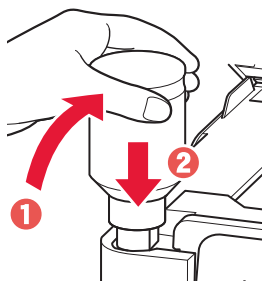

- 5 Внимателно извадете бутилката с мастило от входния отвор.

- Внимавайте да не разлеее мастило.

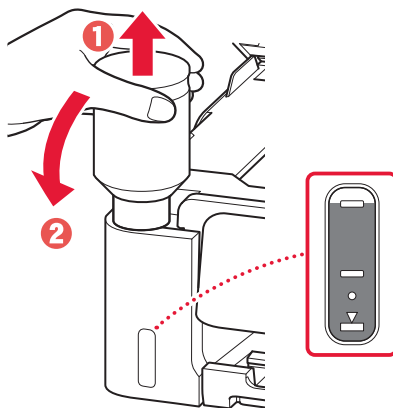

- 6 Поставете **добре** капачката на резервоара обратно на мястото ѝ.

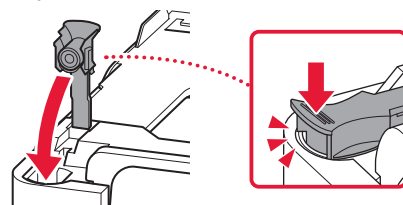

- 7 Повторете стъпки от 1 до 6, за да налеете цялото количество мастило в съответните резервоари за мастило отдясно.

Проверете!

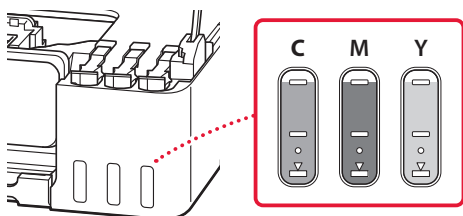

- 8 Затворете сканиращия модул/капака.

- Ако повдигнете леко сканиращия модул/капака и го пуснете, той ще се затвори сам.

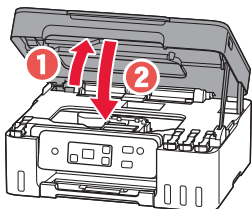

- 9 Когато се покаже екранът по-долу, натиснете бутона **OK**.



- Започва подготовката на системата за мастило. Това отнема около 6 минути. След като приключи, се появява следващият екран.



Изберете метода на свързване, който най-добре съответства на начина, по който ще използвате принтера.

- За използване на принтера без свързване с други устройства
 - ➔ Настройката е завършена.
- За използване на принтера чрез свързване с компютър
 - ➔ Преминете на следващата страница.



Ако се показва някой от следните екрани



Цифри или букви

Проверете екрана и след това изпълнете съответните инструкции по-долу.

E04

Печатащите глави не са поставени правилно.

- ➔ „4. Поставяне на печатащите глави“ на стр. 3

E05

Печатащите глави не могат да бъдат разпознати.

- ➔ „4. Поставяне на печатащите глави“ на стр. 3

За всички други случаи вижте **Онлайн ръководство**.

Настройване на принтера

6. Свързване с компютър



Ако използвате няколко компютъра, извършете тези стъпки на всеки от тях.

- 1 Влезте в уебсайта на Canon директно. Няма нужда да търсите.

<https://ij.start.canon/connect>

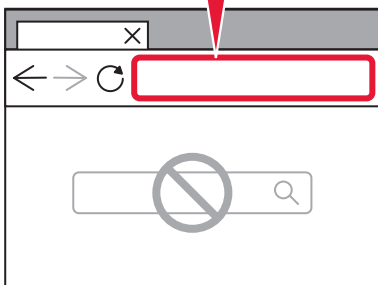

- 2 Въведете името на модела на принтера и щракнете върху **Старт**.
- 3 Следвайте инструкциите на екрана.

Използване на инсталационния компактдиск

1. Щракнете двукратно върху **EasySetup.exe** на екрана, който се показва.
2. Ако се покаже екранът за избор на принтер, изберете **G2470**.
Ако се покаже екранът за инсталиране, щракнете върху **Напред (Next)**.
3. Следвайте инструкциите на екрана.

Ако нищо не се покаже, стартирайте Explorer и след това **EasySetup.exe** от компактдиска.

Зареждане на хартия

- 1 Отворете подложката за хартия.

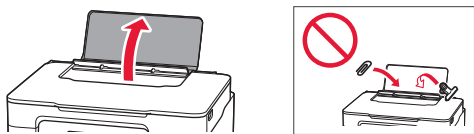

- 2 Плъзнете десния водач за хартия до десния край.

- 3 Заредете няколко листа хартия със страната за печат нагоре и плъзнете страничния водач за хартия до ръба на топчето хартия.

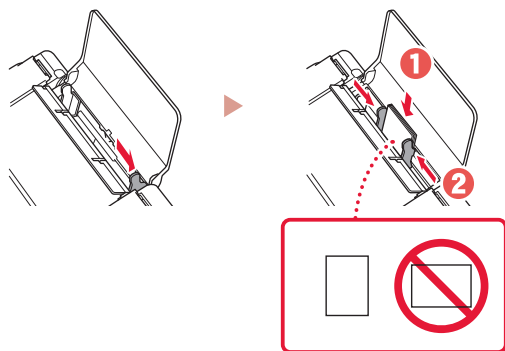

- 4 Натиснете бутона **Избор на хартия (Paper Select)**, изберете размер на хартията и след това натиснете бутона **ОК**.



- 5 Изтеглете изходната тава за хартия.

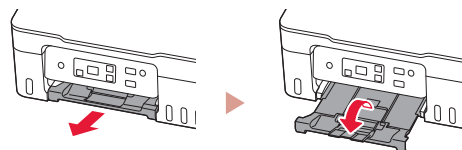

Транспортиране на принтера

Когато премествате принтера, проверете следното. За подробности вижте **Онлайн ръководство**.

Проверете дали капачките на резервоарите са напълно затворени.

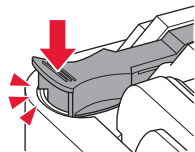

Ако носачът на печатащата глава е в центъра на принтера, проверете дали капакът е затворен.

Опаковайте принтера в найлонов чувал, в случай че протече мастило.

- Опаковайте принтера в твърд кашон, така че да е поставен с долната част надолу, като използвате достатъчно предпазен материал, за да осигурите безопасното му транспортиране.
- Не наклоняйте принтера. Мазилото може да протече.
- Работете внимателно и се уверете, че кашонът винаги остава в хоризонтално положение и НЕ се обръща обратно или настрани, тъй като принтерът може да се повреди и от него да изтече мастило.
- Когато използвате спедиторска фирма за транспортиране на принтера, обозначете кашона с надпис „ТАЗИ СТРАНА НАГОРЕ“, за да се уверите, че принтерът ще бъде поставян с долната му част надолу. Също така го обозначете с надпис „ЧУПЛИВО“ или „ДА СЕ БОРАВИ ВНИМАТЕЛНО“.

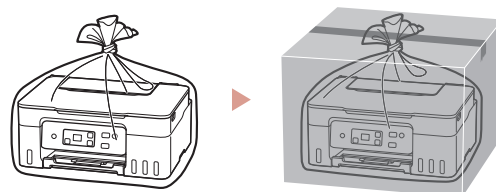

Nameščanje tiskalnika

1. Vsebina kompleta

- Tiskalne glave

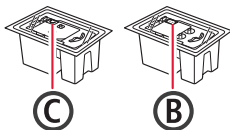

- Steklениčke s črnilom
- Napajalni kabel
- Namestitveni CD
- Informacije o varnosti in pomembne informacije
- Navodila za postavitve in začetek uporabe (ta priročnik)

2. Vklp tiskalnika

- 1 Priključite napajalni kabel.

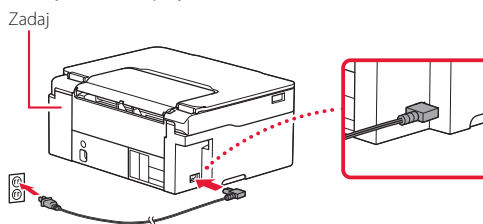

- 2 Pritisnite gumb **VKLOP (ON)**.

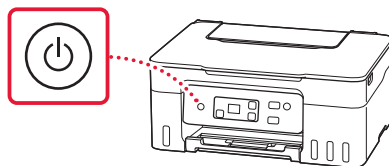

Nameščanje tiskalnika

Enostavna namestitev prek računalnika



Računalnik

Nastavitev s tem priročnikom



Navodila za postavitvev
in začetek uporabe

3

Enostavna namestitev prek računalnika

V vašem računalniku so prikazana preprosta navodila, ki jim zlahka sledite.

- 1 Za začetek nastavitve obiščite spodnji URL.

<https://ij.start.canon/G2470>

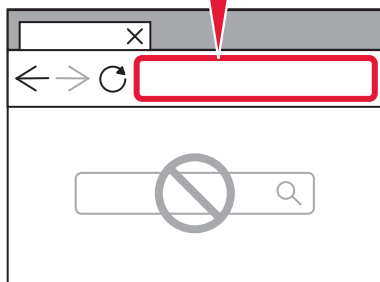

- 2 Za dokončanje nastavitve in tiskanje upoštevajte navodila.

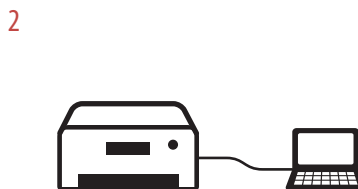
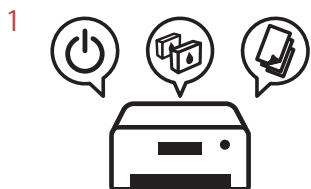

4. Namestitev tiskalnih glav

- 1 Odprite enoto za optično branje/pokrov.

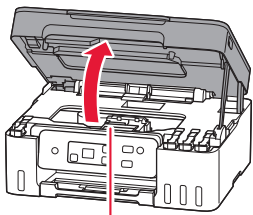

⚠ Pozor

Ne dotikajte se nosilca tiskalne glave, dokler se ne ustavi.

- 2 Odprite pokrov za pritrjevanje tiskalne glave.

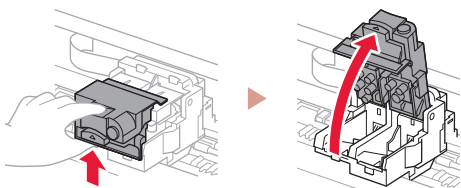

- 3 Vzemite posamezne tiskalne glave iz paketa in odstranite oznako.

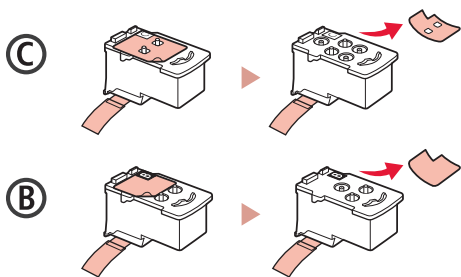

- 4 Odstranite oranžni trak.

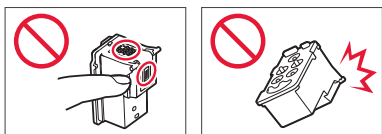
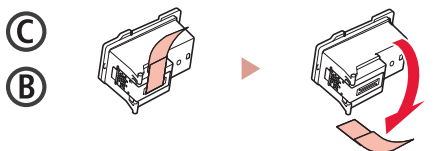

- 5 Vstavite C (barvno) tiskalno glavo na levo stran in B (črno) tiskalno glavo na desno stran.

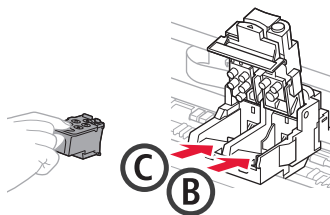

- 6 Zaprite pokrov za pritrjevanje tiskalne glave in pritisnite navzdol, da se zaskoči.

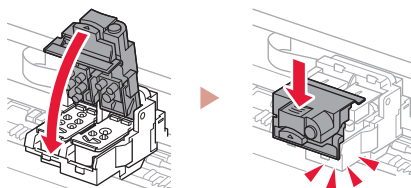

Nameščanje tiskalnika

5. Nalivanje črnila

»»» Pomembno

Pri tem izdelku je treba previdno ravnati s črn timer. Pri polnjenju črnilnih vložkov s črn timer se črn timer lahko polije. Če s črn timer umažete oblačila ali druge predmete, ga morda ne bo mogoče odstraniti.

- 1 Odprite pokrovček vložka na levi strani tiskalnika.

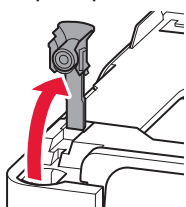

- 2 Stekleničko s črn timer držite pokonci in previdno zavrtite pokrovček stekleničke, da ga odstranite.

Preverite!

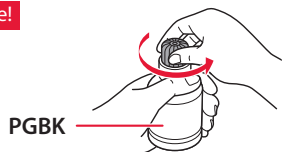

- 3 Šobo stekleničke s črn timer poravnajte z odprtino za dovajanje.

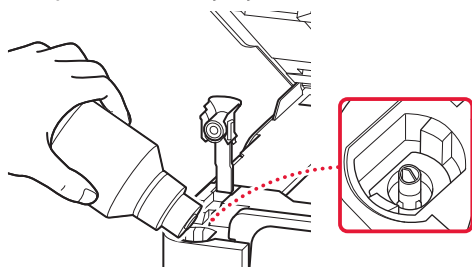

- 4 Stekleničko s črn timer počasi obrnite na glavo in potisnite navzdol, da nalijete črn timer.

- Če se črn timer ne iztoči, previdno odstranite stekleničko s črn timer in poskusite znova.

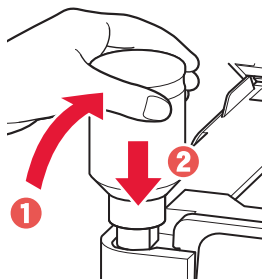

- 5 Stekleničko s črn timer previdno odstranite iz odprtine za dovajanje.

- Pazite, da črn timer ne polijete.

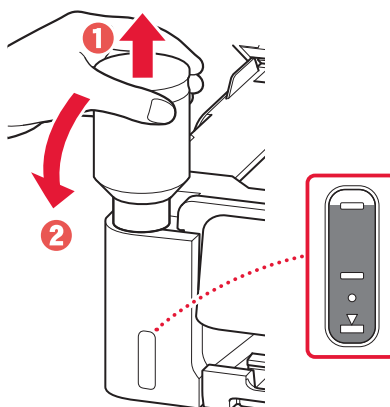

- 6 Znova **trdno** namestite pokrovček vložka.

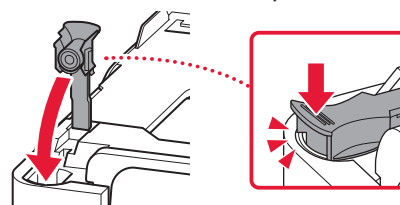

- 7 Ponovite korake od 1 do 6, da vse črnilo vlijete v ustrezne črnilne vložke na desni.

Preverite!

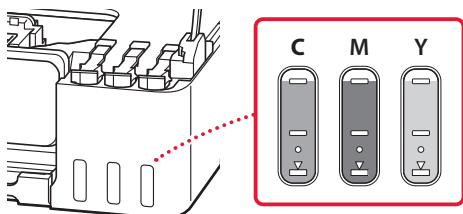

- 8 Zaprite enoto za optično branje/pokrov.

- Če nekoliko dvignete enoto za optično branje/pokrov in ga spustite, se bo sam zaprl.

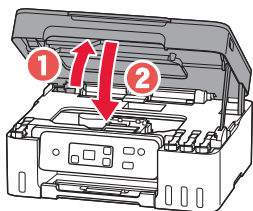

- 9 Ko se prikaže naslednji zaslon, pritisnite gumb **OK**.



- Začne se priprava sistema črnila. To traja približno 6 minut. Ko se postopek dokonča, se prikaže naslednji zaslon.



Izberite način povezave, ki najbolje ustreza temu, kako boste uporabljali tiskalnik.

- Če želite tiskalnik uporabljati brez povezave z drugimi napravami
 - ➔ Nastavitev je zdaj dokončana.
- Za uporabo tiskalnika, povezanega z računalnikom
 - ➔ Nadaljujte na naslednji strani.



Če se pojavi kateri od teh zaslonov



Številke ali črke

Preglejte zaslon in upoštevajte ustrezna navodila spodaj.

E04

Tiskalne glave niso pravilno nameščene.

- ➔ »4. Namestitev tiskalnih glav« na strani 3

E05

Tiskalnih glav ni mogoče prepoznati.

- ➔ »4. Namestitev tiskalnih glav« na strani 3

Za vse druge primere glejte **Spletni priročnik**.

6. Vzpostavljanje povezave z računalnikom



Če uporabljate več računalnikov, te korake izvedite za vsakega od njih.

- 1 Neposredno odprite spletno mesto Canon. Brez iskanja.

<https://ij.start.canon/connect>

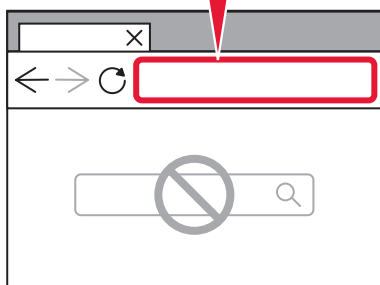

- 2 Vnesite ime modela tiskalnika in kliknite **Pojdi**.
- 3 Sledite navodilom na zaslonu.

Uporaba namestitvenega CD-ja

1. Na zaslonu, ki se prikaže, dvokliknite **EasySetup.exe**.
2. Če se prikaže zaslon za izbiro tiskalnika, izberite **G2470**.
Če se prikaže namestitveni zaslon, kliknite **Naprej (Next)**.
3. Sledite navodilom na zaslonu.

Če se ne prikaže nič, odprite Raziskovalca (Explorer) in nato zaženite datoteko **EasySetup.exe** na CD-ROM-u.

Nalaganje papirja

1 Odprite oporo za papir.

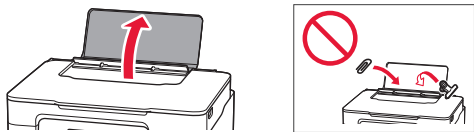

2 Potisnite desno vodilo za papir do konca v desno.

3 Naložite več strani papirja s stranjo za tiskanje obrnjeno navzgor in vodilo za papir potisnite ob rob svežnja papirja.

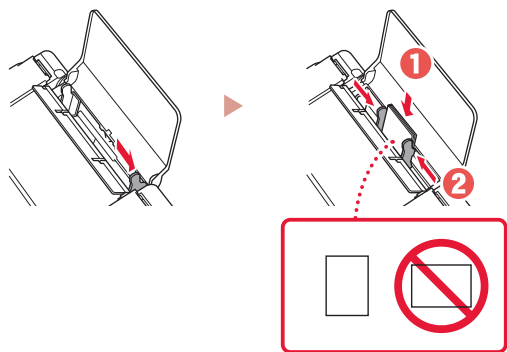

4 Pritisnite gumb **Izbira papirja (Paper Select)**, izberite velikost papirja, nato pa pritisnite gumb **OK**.



5 Razširite izhodni pladenj za papir.

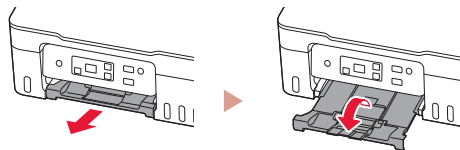

Prevoz tiskalnika

Ko premeščate tiskalnik, preverite spodnje trditve. Za podrobnosti glejte **Spletni priročnik**.

Preverite, če so pokrovčki vložkov popolnoma zaprti.

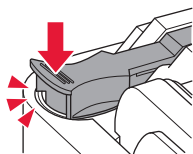

Če je nosilec tiskalne glave na sredini tiskalnika, preverite, ali je pokrov zaprt.

Tiskalnik vstavite v plastično vrečko za primer, da bi črnilo puščalo.

- Tiskalnik shranite v trdno škatlo tako, da je s spodnjim delom obrnjen navzdol. Uporabite dovolj zaščitnega materiala, da bo prenašanje varno.
- Tiskalnika ne nagibajte. Črnilo lahko izteče.
- Ravnajte previdno in škatlo položite na dno, NE na glavo ali na stranice, saj se lahko tiskalnik poškoduje ali začne iztekati črnilo v notranjosti tiskalnika.
- Preden pošljete tiskalnik, škatlo označite z opozorilom »STO STRANJO NAVZGOR«, da bo tiskalnik obrnjen s spodnjim delom navzdol. Označite tudi z oznako »LOMLJIVO« ali »RAVNAJTE PREVIDNO«.

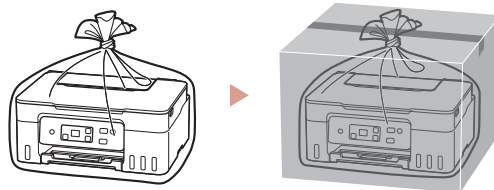

Postavljanje pisača

1. Sadržaj kutije

- Ispisne glave

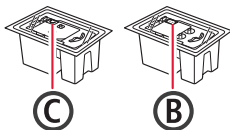

- Bočice tinte

- Kabel za napajanje

- CD-ROM za postavu

- Sigurnosne i važne informacije

- Početak (ovaj priručnik)

2. Uključivanje pisača

- 1 Povežite kabel za napajanje.

Zadnja stranica

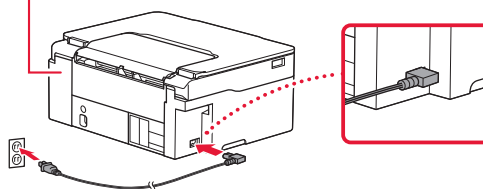

- 2 Pritisnite gumb **UKLJUČENO (ON)**.

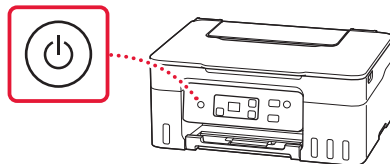

Jednostavno postavljanje pomoću računala



Računalo

Postavljanje pomoću ovog priručnika



Početak

3

Jednostavno postavljanje pomoću računala

Jednostavne upute koje se lako prate prikazuju se na vašem računalu.

- 1 Posjetite URL u nastavku za pokretanje postavljanja.

<https://ij.start.canon/G2470>

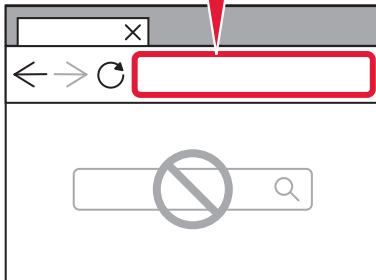

- 2 Slijedite upute za dovršetak postavljanja i ispis.

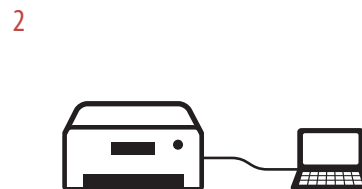

4. Postavljanje ispisnih glava

- 1 Otvorite jedinicu za skeniranje / poklopac.

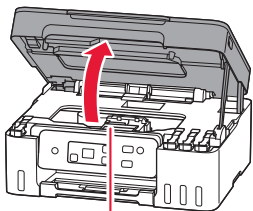

⚠ Oprez

Ne dodirujte držač ispisne glave dok se ne zaustavi.

- 2 Otvorite poklopac za zaključavanje ispisne glave.

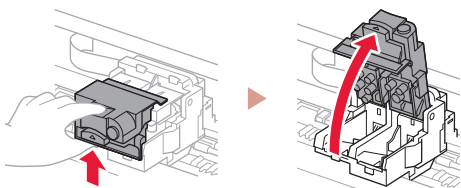

- 3 Izvadite iz paketa svaku ispisnu glavu i uklonite naljepnicu.

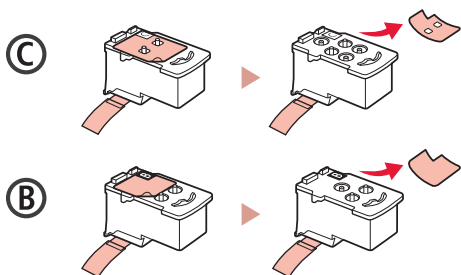

- 4 Skinite narančastu traku.

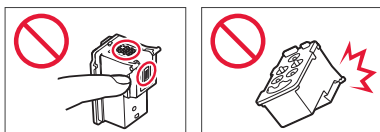
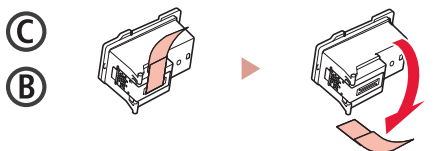

- 5 Umetnite ispisnu glavu C (u boji) na lijevu stranu i ispisnu glavu B (u crnoj boji) na desnu stranu.

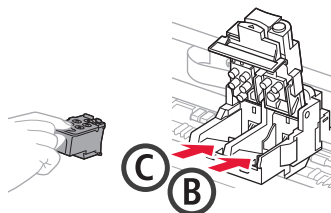

- 6 Zatvorite poklopac za zaključavanje ispisne glave i pritisnite prema dolje dok ne sjedne na mjesto.

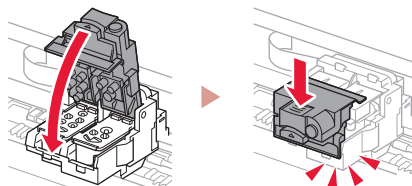

Postavljanje pisača

5. Ulijevanje tinte

»»» Važno

Proizvod zahtijeva oprezno rukovanje tintom. Tinta može prskati kad su spremnici tinte napunjeni. Ako tinta dospije na odjeću ili druge stvari, možda se neće moći odstraniti.

- 1 Otvorite kapicu spremnika na lijevoj strani pisača.

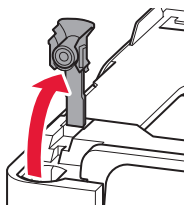

- 2 Uspravno držite bočicu tinte i lagano okrenite kapicu bočice da biste je uklonili.

Provjerite!

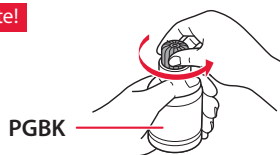

- 3 Poravnajte mlaznicu bočice tinte s ulaznim otvorom.

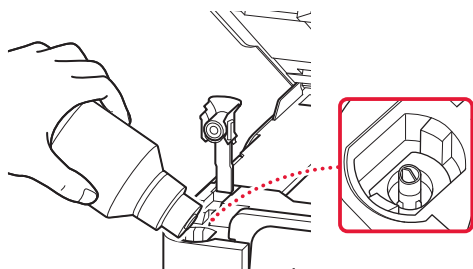

- 4 Polako postavite bočicu tinte naopako i gurnite je prema dolje za ulijevanje tinte.

- Ako se tinta ne ulije, polako uklonite bočicu tinte i pokušajte ponovno.

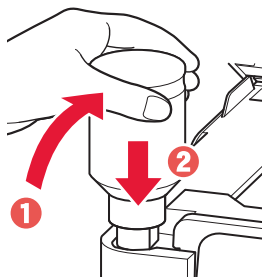

- 5 Polako uklonite bočicu tinte iz ulaznog otvora.

- Pazite da ne prolijete tintu.

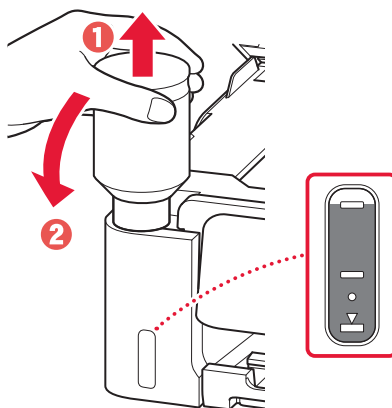

- 6 Zamijenite kapicu spremnika **na siguran način**.

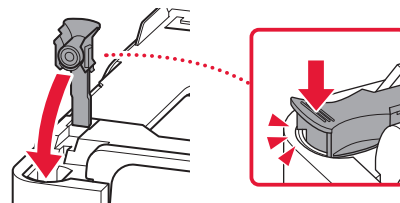

7 Ponovite korake od 1 do 6 za ulijevanje sve tinte u odgovarajuće spremnike tinte na desnoj strani.

Provjerite!

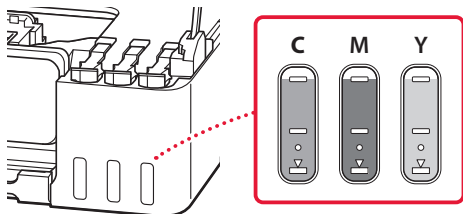

8 Zatvorite jedinicu za skeniranje / poklopac.

- Ako jedinicu za skeniranje / poklopac malo podignete, a zatim pustite, sama će se zatvoriti.

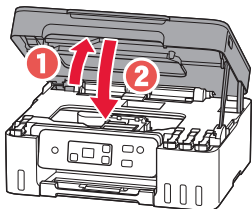

9 Kada se prikaže sljedeći zaslon, pritisnite gumb **U redu (OK)**.



- Započinje priprema sustava tinte. To traje oko 6 minuta. Nakon što završi, prikazat će se sljedeći zaslon.



Odaberite način povezivanja koji najbolje odgovara načinu na koji ćete upotrebljavati pišač.

- Za upotrebu pišača bez povezivanja s drugim uređajima
➔ Postavljanje je sada dovršeno.
- Za upotrebu pišača povezanog s računalom
➔ Prijedite na sljedeću stranicu.



Ako se prikaže bilo koji od sljedećih zaslona



Brojevi ili slova

Provjerite zaslon, a zatim slijedite odgovarajuće upute navedene u nastavku.

E04

Ispisne glave nisu ispravno postavljene.

- ➔ „4. Postavljanje ispisnih glava“ na stranici 3

E05

Ispisne glave nije moguće prepoznati.

- ➔ „4. Postavljanje ispisnih glava“ na stranici 3

Za sve druge slučajeve pogledajte **Priručnik na mreži**.

6. Povezivanje s računalom



Ako koristite više od jednog računala, izvršite ove korake na svakom od njih.

- 1 Pristupite izravno web-mjestu Canon. Nema potrebe tražiti.

<https://ij.start.canon/connect>

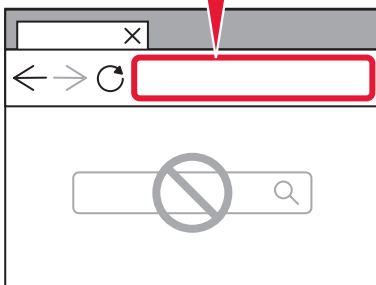

- 2 Unesite naziv modela svog pisača i kliknite **Kreni**.
- 3 Slijedite upute na zaslonu.

Upotreba CD-ROM-a za postavu

1. Na zaslonu koji će se pojaviti dvaput kliknite **EasySetup.exe**.
2. Ako se pojavi zaslon za odabir pisača, odaberite **G2470**.
Ako se pojavi zaslon za instalaciju, kliknite **Dalje (Next)**.
3. Slijedite upute na zaslonu.

Ako se ne pojavi ništa, pokrenite Eksplorer (Explorer), a zatim pokrenite **EasySetup.exe** na CD-ROM-u.

Umetanje papira

- 1 Otvorite oslonac papira.

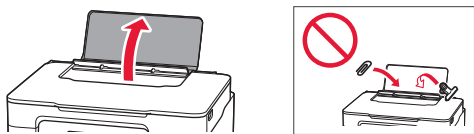

- 2 Povucite desnu vodilicu papira do kraja udesno.

- 3 Umetnite nekoliko listova papira tako da im strana za ispis bude okrenuta prema gore, a bočnu vodilicu papira povucite uz rub snopa papira.

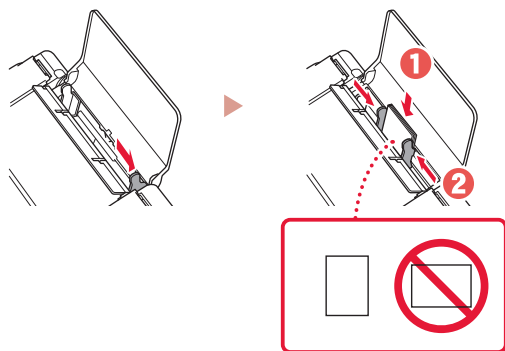

- 4 Pritisnite gumb **Odabir papira (Paper Select)**, odaberite veličinu papira i zatim pritisnite gumb **U redu (OK)**.



- 5 Izvucite ladicu za izlaz papira.

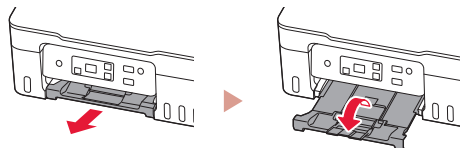

Prijenos pisača

Prilikom premještanja pisača provjerite sljedeće. Za pojedinosti pogledajte **Priručnik na mreži**.

Provjerite jesu li kapice spremnika do kraja zatvorene.

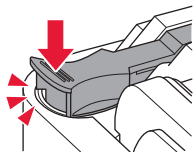

Ako je držač ispisne glave u sredini pisača, provjerite je li poklopac zatvoren.

U slučaju curenja tinte spakirajte pisač u plastičnu vrećicu.

- Spakirajte pisač u čvrstu kutiju tako da donji dio bude okrenut prema dolje i upotrijebite dovoljno zaštitnog materijala da bi prijevoz bio siguran.
- Ne naginjite pisač. Može doći do curenja tinte.
- Pažljivo rukujte kutijom i pobrinite se da ostane na ravnom te je NE okrećite naopako ili na stranu jer se pisač može oštetiti, a tinta može iscuriti iz pisača.
- Ako kurir obavlja prijevoz pisača, na kutiji označite „GORNJA STRANA“ da ne bi okretao pisač naopako. Stavite i oznake „OSJETLJIVO“ ili „PAŽLJIVO RUKOVATI“.

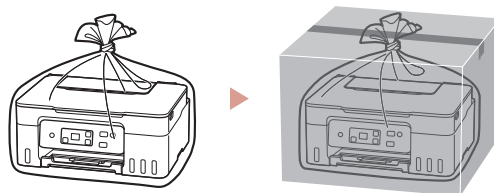



Αποκτήστε πρόσβαση στο Εγχειρίδιο Online
Přečtěte si dokument Příručka online
Prístup k dokumentu Príručka online
Pobierz Podręcznik online
Hogyan érhető el az Online kézikönyv

Çevrimiçi El Kitabı'na erişme
Accesați Manual online
Достъп до Онлайн ръководство
Odprite Spletni priročnik
Pristupite dokumentu Priručnik na mreži

Από το πρόγραμμα περιήγησής σας

Pomocí webového prohlížeče

Cez webový prehliadač

Z przeglądarki

Böngészőből

Tarayıcınızdan

Din browser

От браузър

Prek brskalnika

Iz svog preglednika

